



FENDER, REAR LIGHT BAR /
PANEL, MUD FLAP HANGER &
MUD FLAP ACCESSORIES



QUALITY.

INNOVATION.

DESIGN.

MISSION STATEMENT

HERE AT UNITED PACIFIC, we are dedicated to providing today's drivers with innovative and exciting products that deliver exceptional performance and value. Because United Pacific's continuing success depends on our customer's satisfaction, we constantly push our designers and engineers to upgrade our facilities and processes in order to bring products of superior quality and reliability to the market. We at United Pacific promise to continue our passionate pursuit to be the first in:

QUALITY, INNOVATION AND DESIGN.

QUALITY

With over 30 years of experience in the heavy duty trucking industry, United Pacific Industries understand the rigors and stresses that our products are subjected to on the road. It is our mission to provide our customers with products of superior quality and reliability. In achieving this goal, United Pacific only partners with manufacturing facilities that conforms to our quality control requirements and standards. Our manufacturing partners meet or exceed ISO-9001 requirements. In addition, United Pacific's manufacturing partners must be equipped on site to perform the following quality assurance tests:

- AGING TEST
- AIR TIGHT TEST
- DUST TEST
- FLUX TEST
- PHOTOMETRIC TEST
- PULL FORCE TEST
- RAIN TEST
- SALT SPRAY TEST
- SHOCK TEST
- TEMPERATURE TEST
- HUMIDITY TEST
- VIBRATION TEST



United Pacific's manufacturing partners must maintain a track record of consistent quality and low product failure rate. Furthermore, our internal quality control structure allows us to function as the final quality control station prior to shipping. With the assistance of 3D computer technology, United Pacific can adhere to strict quality control standards during prototype creation and the production process. Our engineers and technicians perform a battery of tests to ensure that our products meet the demands of today's drivers and our goal to be first in quality.





ABOUT US

DESIGN

Located near some of the nation's most progressive automotive design centers, United Pacific established the UP Design Studio in 2002 to consolidate our position as the design leader in the heavy duty trucking industry. UP Design Studio utilizes the latest generation of computer aided design (CAD) and studio/graphic software. The design studio is equipped with the newest computers and rapid prototyping systems. In addition, UP Design Studio is staffed by graduates from the nation's most prestigious design colleges.

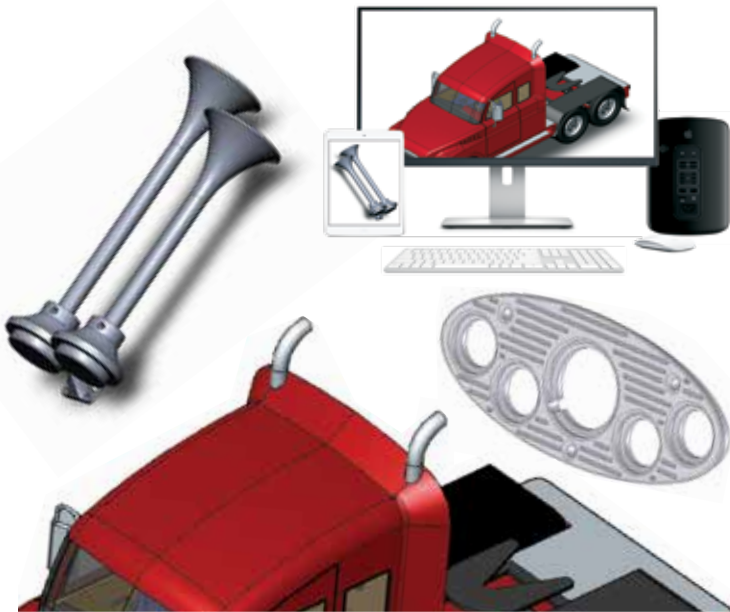

Unlike our competitors, United Pacific's design and manufacturing capabilities mean that we carry more new and original items than our competitors. The establishment of the design studio will enable us to generate even more new products with significant shorter concept-to-shelf time. The reduction in development cost mean that we can develop products utilizing design based development processes. Design based product development allows United Pacific to create new product concepts based on designs incorporating driver demands and needs instead of economic considerations. United Pacific's emphasis on design distinguishes and positions us ahead of our competitors.

HOW TO ORDER

To order from United Pacific Industries, you must be an authorized dealer, distributor or OEM.

If you are not authorized to stock and sell United Pacific products, you must order through an authorized dealer. Please call 1 (800) 790-6988 for more information.

CONTACT US

United Pacific customer service representatives are available from:

8 am - 4:30 pm PST

Toll Free: 1 (800) 790-6988

Fax: 1 (888) 986-5988

Email: sales@uapac.com

Website: www.uapac.com

INNOVATION

Known as the leader in innovation, United Pacific is dedicated to be the first to bring new and exciting products to the market. United Pacific's global expertise allows us to search the globe for new ideas and concepts. Not only do we search the globe for new products, United Pacific invest a significant amount of resources into our own research and development efforts. With the assistance of advance 3D scanning technology, our engineers and designers can acquire accurate and precise data in seconds. The 3D data allows United Pacific to verify designs, perform quality assurance tests, and reverse engineer with unprecedented speed and accuracy. Digital inspection contributes to the early detection of shape problems, provides rapid feedback on design, and eliminates unnecessary work in downstream processes. Our rapid prototyping facility permits us to have a concept-to-shelf time of less than 5 months. In addition, United Pacific's 3D printing capabilities permit our designers to have physical models of their design concepts in hours. The physical models allow our designers and marketing staff to evaluate and test the viability of different design ideas. Our rapid prototyping facility allow United Pacific to compress design cycles, improve manufacturing planning, shorten concept-to-shelf time, most importantly, generate new and innovative products.





WARRANTY

With LED (Light Emitting Diodes) rated at 100,000 hours of operation and solid-state construction, United Pacific's LED lights are extremely reliable and durable. Purchase with confidence, United Pacific offers a complete line of LED lighting products with extended warranties. Please see the warranty policy page for more details.



INVENTORY & SHIPPING

United Pacific carries over 20,000 items in our California distribution center. No other company in the heavy duty trucking industry can match United Pacific in the variety and range of in-stock inventories. With an order fill rate of over 98.5%, United Pacific is the largest and most reliable supplier in the industry. Our shipping department ships 96.8% of all orders within 24 hours and 98.9% within 48 hours. United Pacific's vast inventory and prompt shipping has made United Pacific the only source for our customer's chrome and lighting needs.



ASSEMBLED IN U.S.A..

United Pacific strives to provide today's drivers with innovative and exciting products that deliver exceptional performance and value. With our international background and expertise, we search the globe for the best and most reliable products. However, as an American company, we believe and support the American way of life. Look for the "Assembled in the USA" label on many of our products. Although the components are manufactured overseas, the products, bearing the "Assembled in the USA" labels, are hand assembled with pride in the United States.



Hard at Work for Our Customers. Hard at Work for the Environment



United Pacific
132,000 sq ft
Distribution Center
Long Beach, CA

100% reduction in potable water used for landscaping

40% reduction in total energy use due to high-efficiency mechanical and lighting systems

82% of construction waste was diverted from landfills

LEED ACCOMPLISHMENTS

Sustainable Sites

- On-site bicycle storage, showers and changing areas for company employees
- Preferred parking for low-emitting, fuel-efficient and carpool vehicles
- Stormwater is infiltrated on-site and treated to remove contaminants to reduce environmental impact on local waterways

Water Efficiency

- In addition to using reclaimed water, drought-tolerant plants and a high-efficiency irrigation system were installed to reduce the use of potable water for irrigation by 100%
- High-efficiency water closets, lavatory faucets, and showers were used to reduce annual water use by 30%

Energy and Atmosphere

- Efficient HVAC equipment and a lighting system with daylight controls reduces energy consumption by over 30%
- Enhanced commission verifies that the building's energy and water-related systems are performing as intended by the initial design

Materials and Resources

- Over 81% of construction and demolition waste was diverted from landfills

Indoor Environmental Quality

- Building ventilation system was designed to provide enhanced levels of fresh outside air to building occupants
- Interior finishes (paints, sealants, adhesives, coatings, carpet systems and composite wood) were selected with low levels of volatile organic compounds (VOCs) to reduce indoor air contamination

TABLE OF CONTENT

FENDER, REAR LIGHT BAR / PANEL, MUD FLAP HANGER & MUD FLAP ACCESSORIES CATALOG

	FRONT FENDER	1
	QUARTER FENDER	4
	1 PIECE REAR LIGHT BAR	11
	REAR LIGHT BAR	13
	SPRING LOADED REAR LIGHT BAR	16
	REAR CENTER PANEL	23
	MUD FLAP HANGER	34
	ANTI-SAIL BRACKET/PLATE	41
	TOP MUD FLAP LIGHT BRACKET/WEIGHT	43
	TOP MUD FLAP PLATE/WEIGHT	50
	BOTTOM MUD FLAP PLATE/WEIGHT	51
	RUBBER MUD FLAP	52
	CUTOUTS	53
	TERMS, CONDITIONS & POLICIES	55
	PRODUCT INDEX	59

FRONT FENDER

Aluminum Peterbilt 379 Front Fender

DESCRIPTION

- 0.90 Aluminum, 20% Stronger Than Stock Fender, Made in the USA
- Can Be Painted or Polished to a Mirror Finish for a Custom Look
- No Primer, No Pre-drilled Holes, Inside Liner Not Included
- Sold Each, Please Specify Driver or Passenger Side

Item #	Description	Application	Pack
FF379-01L	PB 379 Front Fender	Driver	Bulk = 1 Pc.
FF379-01R	PB 379 Front Fender	Passenger	Bulk = 1 Pc.



Chrome Peterbilt Front Fender Cover w/ LED Cutout

DESCRIPTION

- Chrome Plastic Peterbilt Front Fender Cover with LED Cutout
- Will Only Fit United Pacific 12" LED Light Bars
- Unique **Patent Pending** Design
- Please Specify Driver or Passenger Side

Item #	Description	Application	Pack
32550	Front Fender LED Cover	Driver	1 Pc./Card
32551	Front Fender LED Cover	Passenger	1 Pc./Card

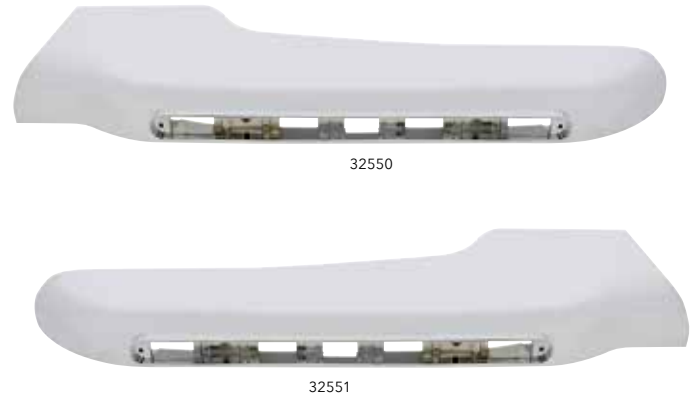

LED Peterbilt Front Fender Cover - Passenger/Right

DESCRIPTION

- Chrome Plastic Peterbilt Front Fender Cover with 12" LED Light Bar
- 12" Light Bar Available with 14 or 19 LEDs in Clear or Colored Lens
- 19 LED 12" Light Bar Available with Chrome Reflector
- 14 LED 12" Light Bar Available with Sequential Flash Function in Clear or Colored Lens, UP Item # 37896B/37898B
- Please Specify Driver or Passenger Side, **Patent Pending**

Item #	LEDs	Lens	Style	Lights
32561	14 Amber	Amber	-	38946B
32563	14 Amber	Clear	-	38948B
32565	14 Amber	Chrome	-	39644B
32567	19 Amber	Amber	Reflector	39773B
32569	19 Amber	Clear	Reflector	39775B
32571	14 Amber	Amber	Sequential	37896B
32573	14 Amber	Clear	Sequential	37898B



LED Peterbilt Front Fender Cover - Driver/Left

DESCRIPTION

- Chrome Plastic Peterbilt Front Fender Cover with 12" LED Light Bar
- 12" Light Bar Available with 14 or 19 LEDs in Clear or Colored Lens
- 19 LED 12" Light Bar Available with Chrome Reflector
- 14 LED 12" Light Bar Available with Sequential Flash Function in Clear or Colored Lens, UP Item # 37896B/37898B
- Please Specify Driver or Passenger Side, **Patent Pending**

Item #	LEDs	Lens	Style	Lights
32560	14 Amber	Amber	-	38946B
32562	14 Amber	Clear	-	38948B
32564	14 Amber	Chrome	-	39644B
32566	19 Amber	Amber	Reflector	39773B
32568	19 Amber	Clear	Reflector	39775B
32570	14 Amber	Amber	Sequential	37896B
32572	14 Amber	Clear	Sequential	37898B



LED Fender Light

LED Fender Light Bracket

DESCRIPTION

- Chrome Die-Cast Fender Light Bracket with LED Marker Light
- LED Lights Available in 3 Different Styles with or without Reflector
- Universal Application, Fits Most Models and Years, Mounting Holes are 7.5" Apart
- Chrome Fender Light Bracket without Light Available Separately: Item # 30678

Item #	LEDs	Lens	Style	Lights
39868	12 Amber	Amber	Rectangular	38134B x 1
39869	12 Amber	Clear	Rectangular	38218B x 1
39870	12 Amber	Amber	Reflector	38305B x 1
39871	12 Amber	Clear	Reflector	38307B x 1
39872	10 Amber	Amber	Reflector	39451B x 1
39873	10 Amber	Clear	Reflector	39453B x 1

Rectangular



Reflector



Reflector



Rectangular Fender Light Bracket

DESCRIPTION

- Chrome Die Cast Fender Light Bracket without Light
- Includes Chrome Bracket and Gasket

Item #	Description	Package	Pack
30678	Chrome Bracket & Gasket	Bulk	1 Pc./Bulk



Fender Guards

Stainless Fender Guard With Headlight Mount - PB 379/378

DESCRIPTION

- 18 Gauge, 304 Stainless
- Includes Mounting Hardware
- Some Drilling Maybe Required for Installation

Item #	Description	Package	Pack
20584	Front Fender Guards with Headlight Mount	Boxed	1 Pair/Box



Stainless Fender Guard - Peterbilt 379/378

DESCRIPTION

- 18 Gauge, 304 Stainless
- Includes Mounting Hardware
- Some Drilling Maybe Required for Installation

Item #	Description	Package	Pack
20572	Front Fender Guards	Boxed	1 Pair/Box



Stainless Steel Front Fender Guards - Peterbilt 370 Series

DESCRIPTION

- Stainless Steel Front Fender Guards
- Peterbilt 370 Series

Item #	Description	Package	Pack
20585	Front Fender Guards	Bulk	1 Pair/Box



Stainless Front Fender Guards - Kenworth W900

DESCRIPTION

- Stainless Steel Front Fender Guards
- Fits Kenworth W900 Trucks

Item #	Description	Package	Pack
20583	Front Fender Guards	Bulk	1 Pair/Bulk

**Stainless Above Headlight Fender Guards - Kenworth T600**

DESCRIPTION

- Stainless Steel Above Headlight Fender Guards for Kenworth T600 Trucks
- Drilling Required, Hardware Included
- 430 Stainless Steel, Sold in Pairs

Item #	Description	Package	Pack
29041	Above Headlight Fender Guards	Carded	1 Pair/Card

**Stainless Below Headlight Fender Guards - Kenworth T600**

DESCRIPTION

- Stainless Steel Below Headlight Fender Guards for Kenworth T600 Trucks
- Drilling Required, Hardware Included
- 430 Stainless Steel, Sold in Pairs

Item #	Description	Package	Pack
29042	Below Headlight Fender Guards	Carded	1 Pair/Card

**Stainless Curved Glass Models Fender Guards - Kenworth T800**

DESCRIPTION

- Fender Guards for 2007+ Kenworth T800 Curved Glass Trucks
- Drilling Required, Hardware Included
- 430 Stainless Steel, Sold in Pairs

Item #	Description	Package	Pack
29043	Front Fender Guards	Boxed	1 Pair/Box

**Stainless Fender Guards - Kenworth T800 Aerocab**

DESCRIPTION

- Under Headlight Fender Guards for Kenworth T800 Aerocab Trucks
- Drilling Required, Hardware Included
- 430 Stainless Steel, Sold in Pairs

Item #	Description	Package	Pack
29044	Front Fender Guards	Carded	1 Pair/Card

**Stainless Fender Guards - International ProStar**

DESCRIPTION

- Stainless Steel Fender Guards for International ProStar Trucks
- Attaches Using Supplied 3M Two-Sided Tape
- 430 Stainless Steel, Sold in Pairs

Item #	Description	Package	Pack
29070	Front Fender Guard	Boxed	1 Pair/Box

**Stainless Fender Light Trim - Kenworth T660**

DESCRIPTION

- Stainless Steel Fender Light Trim for Kenworth T660 Trucks
- Attaches Using Supplied 3M Two-Sided Tape
- 430 Stainless Steel, Sold in Pairs

Item #	Description	Package	Pack
29056	T660 Fender Light Trim	Carded	1 Pair/Card



Stainless Quarter Fender - Tube Bracket

DESCRIPTION

- Stainless Quarter Fender with Tube Bracket, 430 Stainless Steel
- Internal Mounting System, Eliminate the Need for U-Bolts and Other External Hardware, Mounting Post Not Included
- Sold in Pairs, 1 Pair/Set

Item #	Size	S.S. Grade	S.S. Gauge	Pack
10636	24" x 24"	430 Stainless	18 Gauge	1 Pair
10711	24" x 27"	430 Stainless	18 Gauge	1 Pair

REPLACEMENT PARTS

- 10637** Stainless Steel Tube Bracket, Internal Mounting
10786 24" x 24" Quarter Fender Sheets, 430 Stainless Steel, 4 Mounting Hole Cutouts



Stainless Quarter Fender - Triangle Bracket

DESCRIPTION

- Stainless Quarter Fender with Triangle Bracket, 430 Stainless Steel
- Internal Mounting System, Eliminate the Need for U-Bolts and Other External Hardware, Mounting Post Not Included
- Sold in Pairs, 1 Pair/Set

Item #	Size	S.S. Grade	S.S. Gauge	Pack
10808	24" x 24"	430 Stainless	18 Gauge	1 Pair
10809	24" x 27"	430 Stainless	18 Gauge	1 Pair
10814	24" x 29"	430 Stainless	18 Gauge	1 Pair
10855	24" x 31"	430 Stainless	18 Gauge	1 Pair
10854	24" x 34"	430 Stainless	18 Gauge	1 Pair

REPLACEMENT PARTS

- 10629** Stainless Steel Tube Bracket, Internal Mounting
10790 24" x 24" Quarter Fender Sheets, 430 Stainless Steel
10791 24" x 27" Quarter Fender Sheets, 430 Stainless Steel
10792 24" x 29" Quarter Fender Sheets, 430 Stainless Steel
10793 24" x 31" Quarter Fender Sheets, 430 Stainless Steel
10794 24" x 34" Quarter Fender Sheets, 430 Stainless Steel
10806 24" x 36" Quarter Fender Sheets, 430 Stainless Steel

Deluxe Stainless Quarter Fender - Triangle Bracket

DESCRIPTION

- Deluxe Stainless Steel Quarter Fender with Triangle Mounting Bracket
- 8" Standard Mounting Post Tube, Internal Mounting System
- Available in 4 Different Sizes with Deluxe 304 Stainless Steel
- Set Includes: Stainless Fender Sheet, Stainless Triangle Mount, 8" Mounting Post, and Mounting Hardware

Item #	Size	S.S. Grade	S.S. Gauge	Pack
10619	24" x 24"	304 Stainless	18 Gauge	1 Pair
10620	24" x 27"	304 Stainless	18 Gauge	1 Pair
10621	24" x 31"	304 Stainless	16 Gauge	1 Pair
10624	24" x 34"	304 Stainless	16 Gauge	1 Pair
10810	24" x 36"	304 Stainless	16 Gauge	1 Pair

REPLACEMENT PARTS

- 10633** Stainless Steel Triangle Mounting Bracket
10628 24" x 24" Quarter Fender Sheets, 304 Stainless Steel
10795 24" x 27" Quarter Fender Sheets, 304 Stainless Steel
10798 24" x 34" Quarter Fender Sheets, 304 Stainless Steel
10787 24" x 36" Curved Quarter Fender Sheets, 304 Stainless Steel
10831 8" Uni Mount Tube
10634 Stainless Steel Clamp
10634-1 Stainless Steel Heavy Duty Bolt & Nut Set



Stainless Quarter Fender Set - Competition Series

DESCRIPTION

- 24" x 24" Stainless Quarter Fender with Tube Bracket
- Internal Mounting System, Eliminates the Need for U-Bolts and Other External Hardware, Mounting Post Not Included
- Sold in Pairs, Color Retail Box Packaging

Item #	Size	S.S. Grade	S.S. Gauge	Pack
10585	24" x 24"	430 Stainless	18 Gauge	1 Pair



COMPETITION
SERIES

Stainless Quarter Fender - Super Single Tire

DESCRIPTION

- Stainless Quarter Fender with Tube Bracket for Super Single Tire
- Internal Mounting System, Eliminate the Need for U-Bolts and Other External Hardware, Mounting Post Not Included
- Set Includes: Stainless Fender Sheet, Stainless Tube Bracket, Rubber Top Flap, and Mounting Hardware

Item #	Size	S.S. Grade	S.S. Gauge	Pack
10702	18" x 24"	430 Stainless	18 Gauge	1 Pair



Deluxe Stainless Quarter Fender - Flange Mount

DESCRIPTION

- Deluxe Stainless Steel Quarter Fender with 4 Hole Flange Mount
- Available in Deluxe 304 Stainless Steel
- Set Includes: Stainless Fender Sheet, Stainless 4 Hole Flange Bracket, and Mounting Hardware

Item #	Size	S.S. Grade	S.S. Gauge	Pack
10622	24" x 24"	304 Stainless	18 Gauge	1 Pair

REPLACEMENT PARTS

- 10632** Stainless Steel 4 Hole Flange Mount Bracket
- 10628** 24" x 24" Quarter Fender Sheets, 304 Stainless Steel

**Deluxe 304
Stainless**

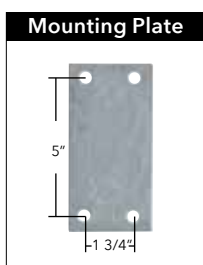

Black Poly Quarter Fender

DESCRIPTION

- Heavy Duty Black Polymer Quarter Fender, Black Polymer is Chip, Dent and Scuff Resistant
- Internal Mounting System, Eliminates the Need for U-Bolts and Other Hardware
- Sold in Pairs, 1 Pair/Box

Item #	Size	Material	Package	Pack
10711	24" x 24"	Poly	Boxed	1 Pair



Deluxe Stainless Quarter Fender - LED Light Bar

DESCRIPTION

- Stainless Steel Quarter Fender with LED Light Bar
- Light Bars Available with 11 or 23 LED in Amber with Colored or Clear Lens
- Available in 24" x 24", 24" x 27", or 24" x 31"
- Sold: Bulk = 1 Pair

Quarter Fender - 11 LED light with Chrome Bezel

Item #	Size	LED	Lens	Bezel
11200	24" x 24"	11 Amber	Amber	34047B
11201	24" x 24"	11 Amber	Clear	34047B
11202	24" x 27"	11 Amber	Amber	34047B
11203	24" x 27"	11 Amber	Clear	34047B
11204	24" x 31"	11 Amber	Amber	34047B
11205	24" x 31"	11 Amber	Clear	34047B

Quarter Fender - 11 LED Light

Item #	Size	LED	Lens	Bezel
11206	24" x 24"	11 Amber	Amber	-
11207	24" x 24"	11 Amber	Clear	-
11208	24" x 27"	11 Amber	Amber	-
11209	24" x 27"	11 Amber	Clear	-
11210	24" x 31"	11 Amber	Amber	-
11211	24" x 31"	11 Amber	Clear	-

Quarter Fender - 23 LED Reflector light with Chrome Bezel

Item #	Size	LED	Lens	Bezel
11212	24" x 24"	23 Amber	Amber	34059B
11213	24" x 24"	23 Amber	Clear	34059B
11214	24" x 27"	23 Amber	Amber	34059B
11215	24" x 27"	23 Amber	Clear	34059B
11216	24" x 31"	23 Amber	Amber	34059B
11217	24" x 31"	23 Amber	Clear	34059B

Quarter Fender - 23 LED Reflector light

Item #	Size	LED	Lens	Bezel
11218	24" x 24"	23 Amber	Amber	-
11219	24" x 24"	23 Amber	Clear	-
11220	24" x 27"	23 Amber	Amber	-
11221	24" x 27"	23 Amber	Clear	-
11222	24" x 31"	23 Amber	Amber	-
11223	24" x 31"	23 Amber	Clear	-

**Recommended Accessories****Deluxe Stainless Quarter Fender Bracket - LED Light Bar**

DESCRIPTION

- Deluxe Stainless Steel Quarter Fender Bracket with LED Light Bar
- Light Bars Available with 11 or 23 LED in Amber or Red
- Stainless Steel Quarter Fender Bracket without LED Light Bar Available Separately: UP Item # 10630
- Sold: Bulk = 1 Pair

Quarter Fender Bracket - 11 LED light with Chrome Bezel

Item #	LED	Lens	Lights	Bezel
10815	11 Amber	Amber	38463B	34047B
10816	11 Red	Red	38469B	34047B
10817	11 Amber	Clear	38464B	34047B
10818	11 Red	Clear	38470B	34047B

Quarter Fender Bracket - 11 LED light

Item #	LED	Lens	Lights	Bezel
10819	11 Amber	Amber	38463B	-
10820	11 Red	Red	38469B	-
10821	11 Amber	Clear	38464B	-
10822	11 Red	Clear	38470B	-

Quarter Fender Bracket - 23 LED Reflector light w/ Chrome Bezel

Item #	LED	Lens	Lights	Bezel
10856	11 Amber	Amber	39763B	34059B
10857	11 Red	Red	39764B	34059B
10858	11 Amber	Clear	39765B	34059B
10859	11 Red	Clear	39766B	34059B

Quarter Fender Bracket - 23 LED Reflector light

Item #	LED	Lens	Lights	Bezel
10825	11 Amber	Amber	39763B	-
10826	11 Red	Red	39764B	-
10827	11 Amber	Clear	39765B	-
10828	11 Red	Clear	39766B	-



Stainless Quarter Fender Blank - Tube Bracket

DESCRIPTION

- Stainless Steel Quarter Fender Blank, Quarter Fender Blank Only, No Mounting Hardware Included, Mounting Holes are Precut
- Precut with 4 Mounting Holes Designed for United Pacific Economy Quarter Fender (UP item # 10636) and Tube Bracket (UP item # 10631)

Item #	Size	S.S. Grade	S.S. Gauge	Pack
10786	24" x 24"	430 Stainless	18 Gauge	1 Pair



Stainless 36" Curved Quarter Fender Blank - Triangle/U-Clamp

DESCRIPTION

- Stainless Steel Curved Quarter Fender Blank, Curved Fender Blank Only, No Mounting Hardware Included, Mounting Holes are Precut
- Available in Deluxe 304 or 430 Stainless Steel

Item #	Size	S.S. Grade	S.S. Gauge	Pack
10787	24" x 36"	304 Stainless	16 Gauge	1 Pair
10806	24" x 36"	430 Stainless	16 Gauge	1 Pair



Stainless Quarter Fender Blank - Triangle/U-Clamp

DESCRIPTION

- Stainless Steel Quarter Fender Blank, Quarter Fender Blank Only, No Mounting Hardware Included, Mounting Holes are Precut
- Mounting Holes Precut for Brackets with 3 Mounting Plates
- Available in Deluxe 304 Stainless Steel or 430 Stainless Steel
- **WILL NOT** Fit United Pacific Quarter Fender with Tube Bracket (UP Item # 10636) or Tube Bracket (UP Item # 10637)

Deluxe Quarter Fender Sheet - 304 Stainless Steel

Item #	Size	S.S. Grade	S.S. Gauge	Pack
10628	24" x 24"	304 Stainless	18 Gauge	1 Pair
10795	24" x 27"	304 Stainless	18 Gauge	1 Pair
10796	24" x 29"	304 Stainless	16 Gauge	1 Pair
10800	24" x 30"	304 Stainless	16 Gauge	1 Pair
10798	24" x 34"	304 Stainless	16 Gauge	1 Pair

Deluxe Quarter Fender Sheet - 430 Stainless Steel

Item #	Size	S.S. Grade	S.S. Gauge	Pack
10790	24" x 24"	430 Stainless	18 Gauge	1 Pair
10791	24" x 27"	430 Stainless	18 Gauge	1 Pair
10792	24" x 29"	430 Stainless	16 Gauge	1 Pair
10793	24" x 31"	430 Stainless	16 Gauge	1 Pair
10794	24" x 34"	430 Stainless	16 Gauge	1 Pair



SEE ALL OF UNITED PACIFIC PRODUCTS IN ONE PLACE!

truck.uapac.com

Stainless Quarter Fender Bracket - Tube

DESCRIPTION

- 430 Stainless Steel Tube Quarter Fender Bracket
- Includes: Tube Bracket, Fastener, and Mounting Hardware

Item #	Description	Pack
10637	Tube Mounting Bracket	1 Pair

**Deluxe Stainless Quarter Fender Bracket - Tube/U-Clamps**

DESCRIPTION

- Deluxe Stainless Steel Tube Fender Bracket
- Includes: Round Tube Bracket, U-Clamps, and Mounting Hardware

Item #	Description	Pack
10631	Tube Mounting Bracket	1 Pair

**Stainless Quarter Fender Bracket - Triangle**

DESCRIPTION

- Stainless Steel Quarter Fender Triangle Mounting Bracket
- Available in 430 Stainless Steel or 304 Stainless Steel
- Includes: Triangle Bracket, Fastener and Mounting Hardware
- Eliminates the Need for U-Bolts and Other External Hardware

Item #	Description	S.S. Grade	Pack
10633	Triangle Mounting Bracket	304 Stainless	1 Pair
10629	Triangle Mounting Bracket	430 Stainless	1 Pair

**Deluxe Stainless Quarter Fender Bracket - LED Cutout**

DESCRIPTION

- Deluxe Stainless Steel Quarter Fender Bracket with LED Cutout
- Includes: Fender Bracket, Fastener, and Mounting Hardware

Item #	Description	Pack
10630	Mounting Bracket with LED Cutout	1 Pair

**Deluxe Stainless 36" Quarter Fender Bracket Kit**

DESCRIPTION

- Stainless Steel Triangle Quarter Fender Bracket Kit for 24" x 36" Fenders
- Includes: 304 Stainless Steel Triangle Bracket, Fastener, and Mounting Hardware, also Includes Reinforcement Plate to Support the Extra Large 36" Fender

Item #	Description	Pack
10807	36" Fender Mounting Kit	1 Pair

**Deluxe Stainless Quarter Fender Bracket - Flange Mount**

DESCRIPTION

- Deluxe Stainless Steel 4 Hole Flange Mount Quarter Fender Bracket
- Includes: Flange Mounting Bracket, Fastener, and Mounting Hardware

Item #	Description	Pack
10632	Flange Mounting Bracket	1 Pair

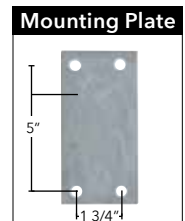

Stainless Quarter Fender Bracket - Airleaf

DESCRIPTION

- Stainless Steel Airleaf Full/Half Tandem Fender Bracket
- Please Specify Driver or Passenger Side, Available in 304 or 430 Stainless Steel, Sold: Bulk = 1 Pc.

Item #	Description	Side	S.S. Grade
10788	Airleaf Mounting Bracket	Driver	304 Stainless
10789	Airleaf Mounting Bracket	Passenger	304 Stainless
10823	Airleaf Mounting Bracket	Driver	430 Stainless
10824	Airleaf Mounting Bracket	Passenger	430 Stainless



Stainless Quarter Fender Tube

DESCRIPTION

- Stainless Steel Quarter Fender Tube/Pipe Only
- Replacement Tube/Pipe for UP Item # 10631

Item #	Description	Pack
25001	Quarter Fender Pipe/Tube	Bulk = 1 Pc.



Deluxe Stainless Quarter Fender Bracket - Air Trac

DESCRIPTION

- Deluxe 304 Stainless Steel Air Trac Quarter Fender Bracket
- Please Specify Driver or Passenger Side, Sold: Bulk = 1 Pc.

Item #	Description	Side	Pack
10782	Air Trac Mounting Bracket	Driver	1 Pc.
10783	Air Trac Mounting Bracket	Passenger	1 Pc.

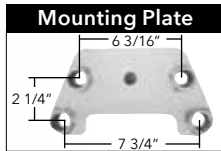

Quarter Fender Mounting Post

DESCRIPTION

- Standard 8" Long Quarter Fender Mounting Post Tube
- Post Only, Mounting Hardware Not Included

Item #	Description	Pack
10831	Quarter Fender Mounting Post	Bulk = 1 Pc.



Stainless Quarter Fender Bracket - Lo-Air

DESCRIPTION

- Stainless Steel Lo-Air Quarter Fender Bracket
- Please Specify Driver or Passenger Side, Available in 304 or 430 Stainless Steel, Sold: Bulk = 1 Pc.

Item #	Description	Side	S.S. Grade
10784	Lo-Air Mounting Bracket	Driver	304 Stainless
10785	Lo-Air Mounting Bracket	Passenger	304 Stainless
10852	Lo-Air Mounting Bracket	Driver	430 Stainless
10853	Lo-Air Mounting Bracket	Passenger	430 Stainless

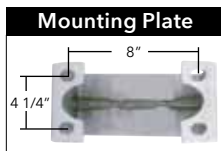

Quarter Fender Mounting Post - Flange Mount

DESCRIPTION

- Standard Flange Mount Quarter Fender Mounting Post
- Mounting Post Only, Mounting Hardware Not Included

Item #	Description	Pack
10832	Flange Mount Mounting Post	Bulk = 1 Pc.

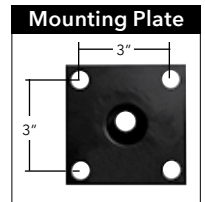

Quarter Fender Clamp

DESCRIPTION

- Quarter Fender Clamp for Quarter Fender Bracket
- Available in Chrome or Stainless Steel Clamp Only

Item #	Description	Material	Pack
10634	Quarter Fender Clamp	Stainless	Bulk = 1 Pc.
10635	Quarter Fender Clamp	Chrome	Bulk = 1 Pc.



Quarter Fender Clamp Hardware

DESCRIPTION

- Stainless Steel Heavy Duty Nut and Bolt Set for Quarter Fender Clamp
- Sold in Sets, Set Includes: 1 Bolt and 1 Nut

Item #	Description	Pack
10634-1	Quarter Fender Clamp Hardware	Bulk = 1 Set



Quarter Fender Top Mud Flap

DESCRIPTION

- 6" x 24" Black Rubber Top Mud Flap For United Pacific Quarter Fender

Item #	Description	Package	Pack
10611	6" x 24" Top Mud Flap	Bulk	1 Pc.

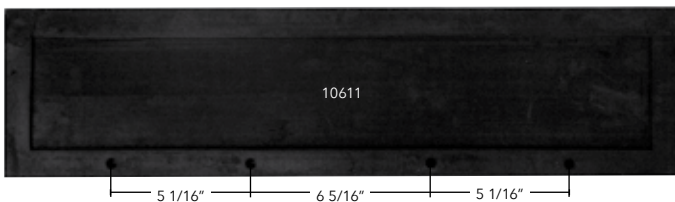

Top Mud Flap Mounting Hardware

DESCRIPTION

- Top Mud Flap Mounting Hardware for United Pacific Stainless Steel Quarter Fenders
- 1 Kit Includes Hardware to Install 2 Top Mud Flaps

Item #	Description	Package	Pack
10804	Top Mud Flap Kit	Bulk	1 Kit

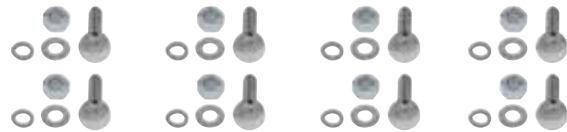

Quarter Fender Hardware

DESCRIPTION

- Mounting Hardware for United Pacific Stainless Steel Quarter Fenders
- For Installing Quarter Fender Sheets to Round Pipes with Internal Mounting
- 1 Kit Includes Hardware to Install 2 Quarter Fenders

Item #	Description	Package	Pack
10839	Fender Mounting Kit	Bulk	1 Kit



1 PIECE REAR LIGHT BAR

Recommended Accessories



1 Piece Rear Light Bar

DESCRIPTION

- 1 Piece Rear Light Bar with Six 4" Light Cutouts
- Available in Chrome or Stainless Steel Light Bar Only
- Oversized Item

Item #	Material	Light Holes	Package	Pack
30237	Chrome	6	Bulk	1 Pc.
20237	Stainless	6	Bulk	1 Pc.

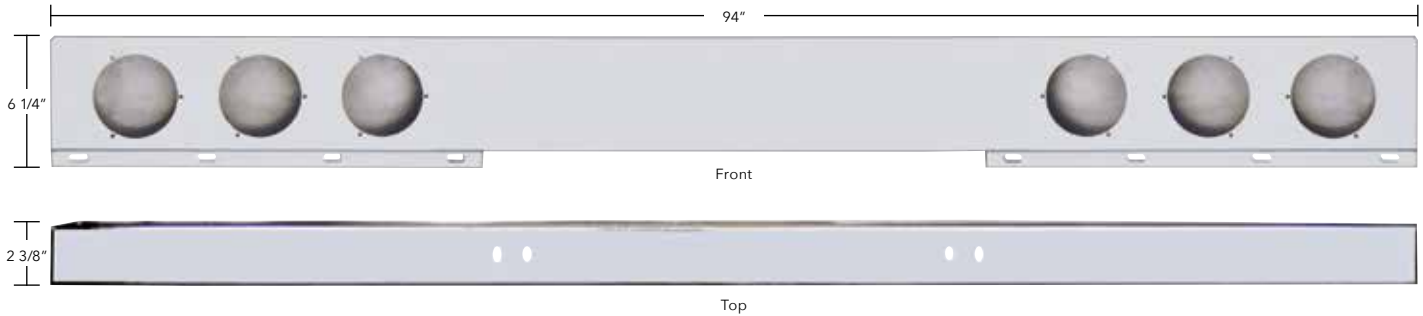

1 Piece Rear Light Bar - 4" LED Light x 6

DESCRIPTION

- 1 Piece Rear Light Bar with Six 4" LED Lights
- Available in Chrome or Stainless Steel, Available with Chrome Plastic Light Bezel with or without Visor (Item # 10483 / 10484)

Item # with Visor	Item # with Bezel	LED Lights				Rear Light Bar	
		4" LED	Item #	LEDs	Lens	Item #	Finish
61736	62776		39924B x 6	7 Red	Red	30237	Chrome
61737	62777		39925B x 6	7 Red	Clear	30237	Chrome
61647	62647		39642B x 6	36 Red	Red	30237	Chrome
61648	62648		39643B x 6	36 Red	Clear	30237	Chrome
61411	62411		38116B x 6	12 Red	Red	30237	Chrome
61412	62412		38117B x 6	12 Red	Clear	30237	Chrome
61413	62413		38770B x 6	10 Red	Red	30237	Chrome
61414	62414		38772B x 6	10 Red	Clear	30237	Chrome
61738	62778		39924B x 6	7 Red	Red	20237	Stainless
61739	62779		39925B x 6	7 Red	Clear	20237	Stainless
61649	62649		39642B x 6	36 Red	Red	20237	Stainless
61650	62650		39643B x 6	36 Red	Clear	20237	Stainless
61419	62419		38116B x 6	12 Red	Red	20237	Stainless
61420	62420		38117B x 6	12 Red	Clear	20237	Stainless
61421	62421		38770B x 6	10 Red	Red	20237	Stainless
61422	62422		38772B x 6	10 Red	Clear	20237	Stainless

1 Piece Rear Light Bar - 4" Incandescent Light x 6

DESCRIPTION

- 1 Piece Rear Light Bar with Six 4" Incandescent Lights
- Available in Chrome or Stainless Steel, Available with Chrome Plastic Light Bezel with or without Visor (Item # 10483 / 10484)
- 4" Incandescent Light Available Separately (Item # 31109)

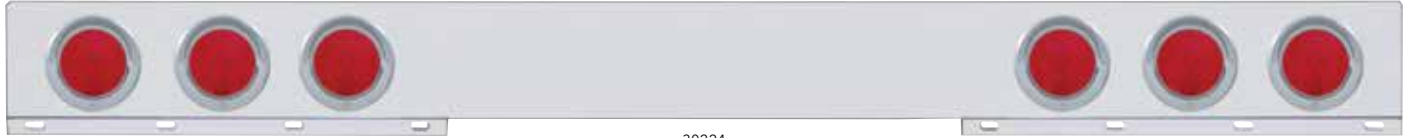

30224

Item # with Visor	Item # with Bezel	Incandescent Lights				Rear Light Bar	
		4" Incandescent Lights	Item #	Type	Lens	Item #	Finish
30224	30274		31109 x 6	Incandescent	Red	30237	Chrome
20235	20996		31109 x 6	Incandescent	Red	20237	Stainless

Black Mounting Bracket

DESCRIPTION

- Black Rear Light Bar Mounting Bracket
- Sold in Pairs

Item #	Description	Package	Pack
20231	Black Mounting Bracket	Bulk	1 Pair



"L" Shape Mounting Bracket

DESCRIPTION

- "L" Shape Mounting Bracket for Light Bar Mud Flap
- Sold in Pairs
- Hardware Not Included

Item #	Description	Package	Pack
30231-1	"L" Mounting Bracket	Bulk	1 Pair



REAR LIGHT BAR

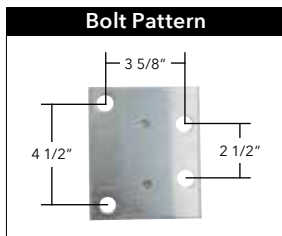

Chrome Rear Light Bar - 4 Hole Flange Mount

DESCRIPTION

- Rear Light Bars with Six 4" Light Cutouts, 4 Hole Flange Mount
- Each Light Bar has Three 4" Round Light Cutouts (Total 6 Cutouts), Fits 6 Lights Total

Item #	Material	Light Holes	Package	Pack
30231	Chrome	6	Bulk	1 Pair

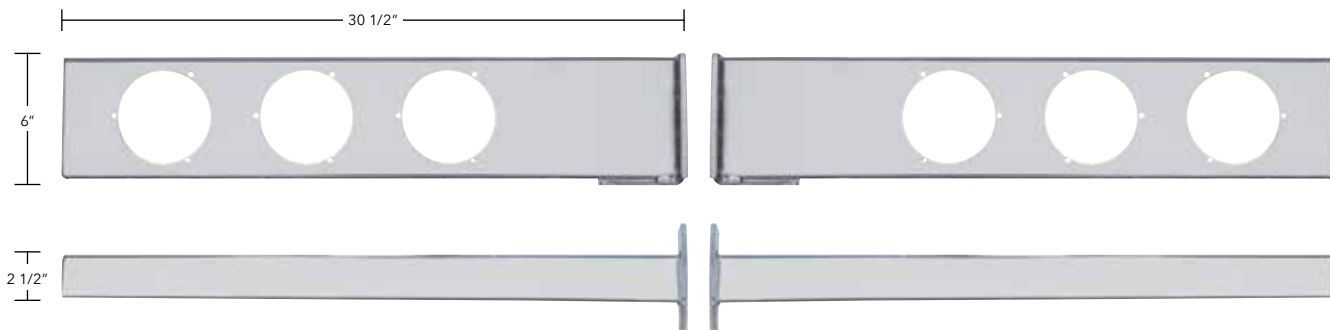

Chrome Rear Light Bar - 4" LED Light x 6

DESCRIPTION

- Chrome Rear Light Bar with Six 4" Round LED Lights, 4 Hole Flange Mount
- Available with Chrome Plastic Light Bezel with or without Visor (Item # 10483 / 10484)

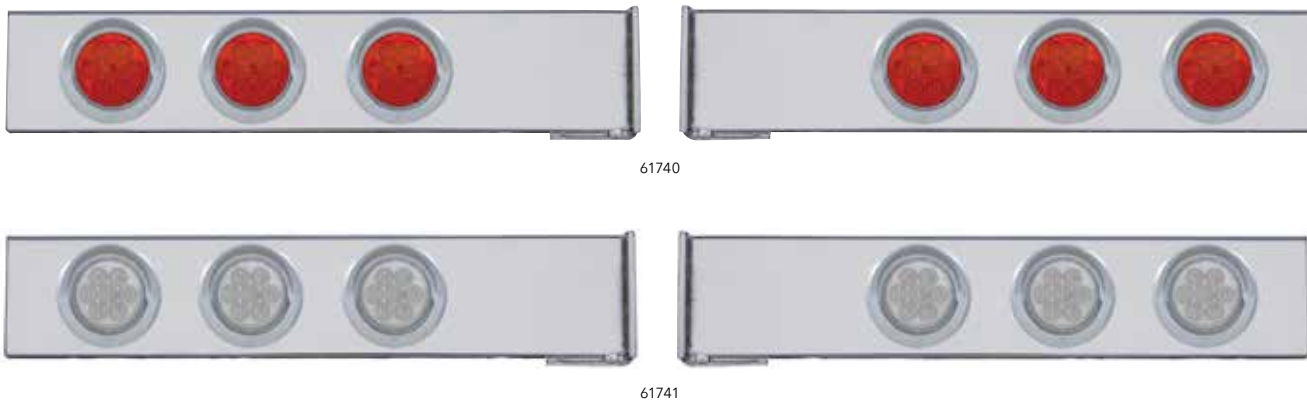

Item # with Visor	Item # with Bezel	LED Lights				Rear Light Bar	
		4" LED	Item #	LEDs	Lens	Item #	Finish
61740	62780		39924B x 6	7 Red	Red	30231	Chrome
61741	62781		39925B x 6	7 Red	Clear	30231	Chrome
61659	62659		39642B x 6	36 Red	Red	30231	Chrome
61660	62660		39643B x 6	36 Red	Clear	30231	Chrome
61467	62467		38116B x 6	12 Red	Red	30231	Chrome
61468	62468		38117B x 6	12 Red	Clear	30231	Chrome
61469	62469		38770B x 6	10 Red	Red	30231	Chrome
61470	62470		38772B x 6	10 Red	Clear	30231	Chrome

Chrome Rear Light Bar - 4 Hole Flange Mount

DESCRIPTION

- Rear Light Bar with 6 Slanted 6" Oval Light Cutouts, 4 Hole Flange Mount
- Each Light Bar has 3 Slanted Oval Cutouts (Total 6 Cutouts), Fits 6 Lights Total

Item #	Material	Light Holes	Package	Pack
30227	Chrome	6	Bulk	1 Pair

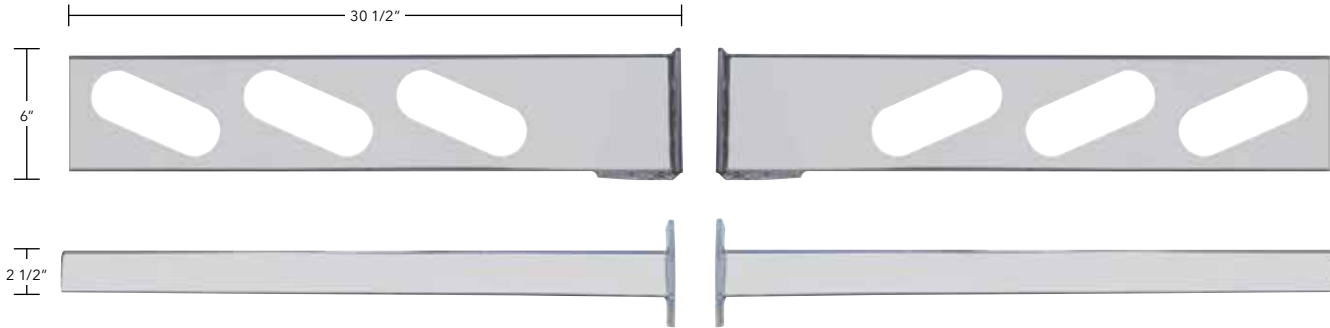
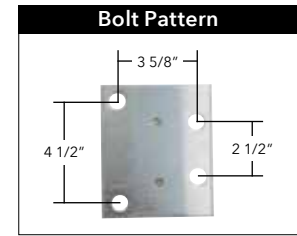

Chrome Rear Light Bar - Oval LED Light x 6

DESCRIPTION

- Chrome Rear Light Bar with 6 Slanted 6" Oval LED Lights, 4 Holes Flange Mount
- Available with Chrome Plastic Light Bezel with or without Visor (Item # 10489 / 10490)

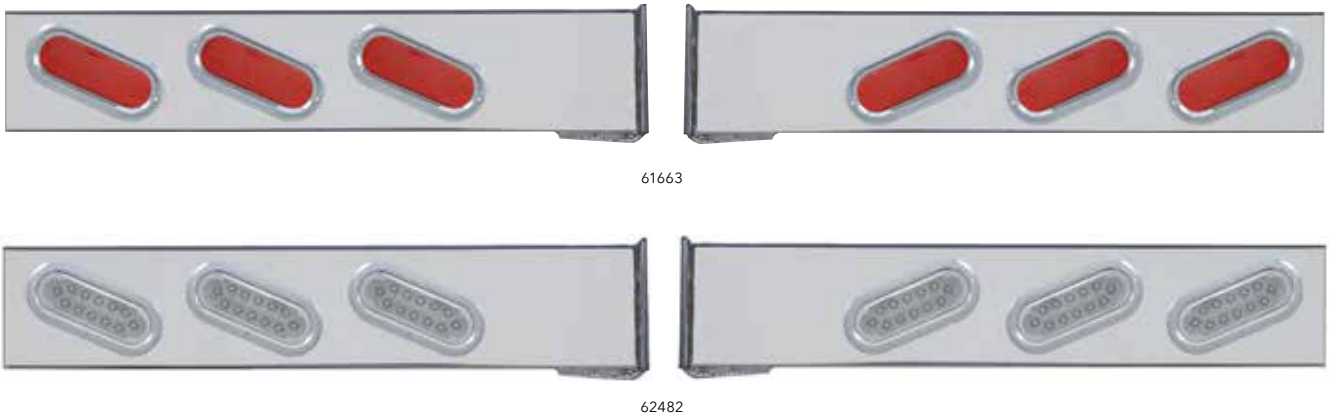

Item # with Visor	Item # with Bezel	LED Lights				Rear Light Bar	
		Oval LED	Item #	LEDs	Lens	Item #	Finish
61663	62663		39703B x 6	19 Red	Red	30227	Chrome
61664	62664		39705B x 6	19 Red	Clear	30227	Chrome
61481	62481		38121B x 6	12 Red	Red	30227	Chrome
61482	62482		38122B x 6	12 Red	Clear	30227	Chrome
61483	62483		38774B x 6	12 Red	Red	30227	Chrome

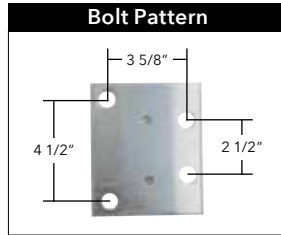

Chrome Rear Light Bar - 4" Incandescent Light x 6

DESCRIPTION

- Chrome Rear Light Bar with Six 4" Round Incandescent Lights
- Available with Chrome Plastic Light Bezel with or without Visor (Item # 10483 / 10484)
- 4" Round Incandescent Light Available Separately (Item # 31109)



31611

Item # with Visor	Item # with Bezel	Incandescent Lights				Rear Light Bar	
		4" Incandescent Lights	Item #	Type	Lens	Item #	Finish
31611	31004		31109 x 6	Incandescent	Red	30231	Chrome

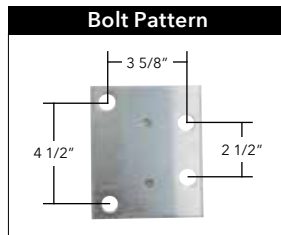

Chrome Rear Light Bar - Oval Incandescent Light x 6

DESCRIPTION

- Chrome Rear Light Bar with Six 6" Oval Incandescent Lights
- Available with Chrome Plastic Light Bezel with or without Visor (Item # 10489 / 10490)
- 6" Oval Incandescent Light Available Separately (Item # 31362)



30226

Item # with Visor	Item # with Bezel	Incandescent Lights				Rear Light Bar	
		Oval Incandescent Lights	Item #	Type	Lens	Item #	Finish
30226	31005		31362 x 6	Incandescent	Red	30227	Chrome

Product FYI

Bolt Pattern

The term "bolt pattern" refers to the spacing of the mounting holes/bolts at the end of the light bar. Bolt pattern measures the distance from center to center of each bolt as shown below. The light bar mounts to the frame of the truck through these bolts. Pre-drilled holes for mounting light bars and mud flap hangers exist on most trucks. Easiest mounting method is to match the bolt pattern on the light bar with the existing mounting holes on the frame of the truck. United Pacific offers four different bolt patterns.

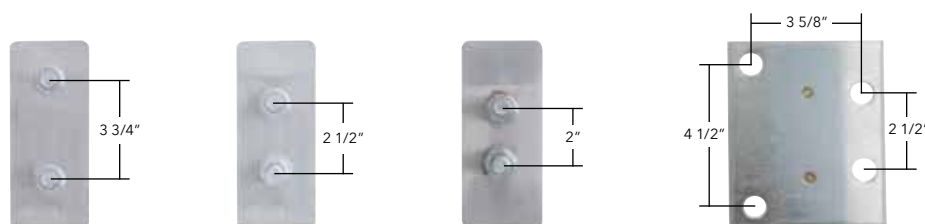

SPRING LOADED REAR LIGHT BAR

Bolt Pattern

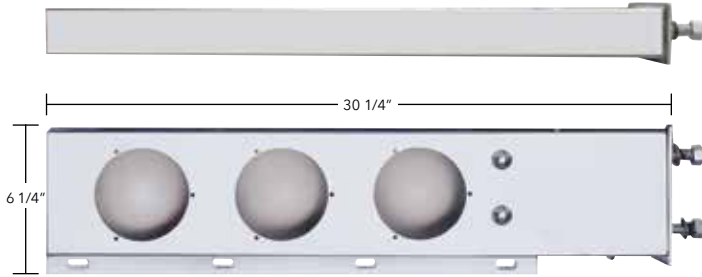
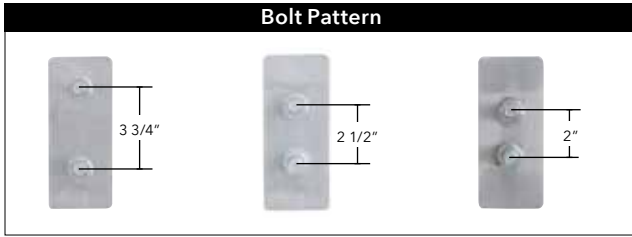

Spring Loaded Rear Light Bar - 4" Round Cutouts

DESCRIPTION

- Spring Loaded Rear Light Bar with Six 4" Round Light Cutouts
- Available with 3 3/4", 2 1/2", or 2" Bolt Pattern
- Each Light Bar has Three 4" Light Cutouts (Total 6 Cutouts)
- Available in Chrome or Stainless Steel Light Bar

Item #	Material	Bolt Patterns	Light Holes	Pack
31616	Chrome	3 3/4"	6	1 Pair
31615	Chrome	2 1/2"	6	1 Pair
22237	304 Stainless	3 3/4"	6	1 Pair
22300	430 Stainless	3 3/4"	6	1 Pair
22301	430 Stainless	2 1/2"	6	1 Pair
22302	430 Stainless	2"	6	1 Pair



Bolt Pattern

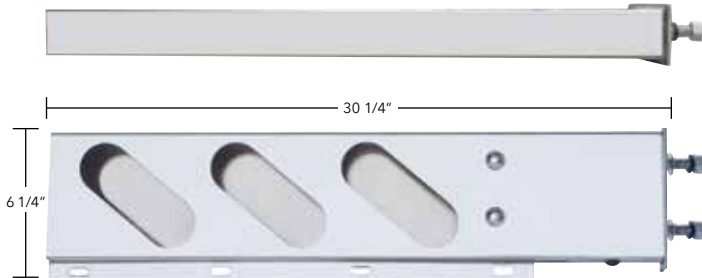
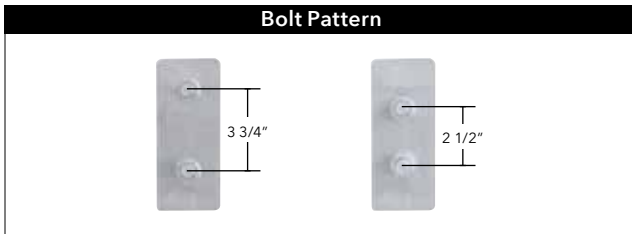

Spring Loaded Rear Light Bar - 6" Oval Cutouts

DESCRIPTION

- Spring Loaded Rear Light Bar with Six 6" Oval Light Cutouts
- Available with 3 3/4" or 2 1/2" Bolt Patterns
- Each Light Bar has Three Slanted Up Oval Light Cutouts (Total 6 Cutouts)
- Available in Chrome or Stainless Steel Light Bar

Item #	Material	Bolt Patterns	Light Holes	Pack
31620	Chrome	2 1/2"	6	1 Pair
22303	430 Stainless	3 3/4"	6	1 Pair
22304	430 Stainless	2 1/2"	6	1 Pair



Product FYI

Spring Loaded vs. Standard Light Bar

Spring loaded light bars and mud flap hangers integrate a heavy-duty internal spring that permits the light bar or hanger to bend when struck. The internal spring snaps the light bar or mud flap hanger back into position when the obstruction is clear. Depending on the force of the impact, spring loaded light bars and mud flap hangers may continue to function even with some minor physical damage. Severely damaged light bars and mud flap hangers should be removed or replaced immediately.

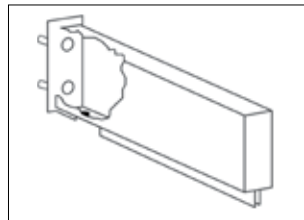

Standard Light Bars

The standard light bar has two internal bolts welded to a thick steel end plate to provide a secure attachment point.

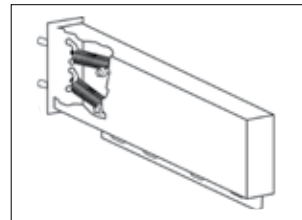

Spring Loaded Light Bars

With two small springs under tension, spring loaded light bars can snap back into position after impact. Spring is not sold separately.

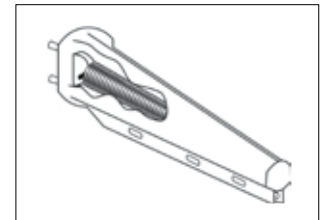

Spring Loaded Mud Flap Hanger

With only one large spring under tension, spring loaded mud flap hangers function like a spring loaded light bar, snapping the hanger back into position after impact. Spring is sold separately.



Chrome Spring Loaded Rear Light Bar - 3 3/4" Bolt Pattern

DESCRIPTION

- Spring Loaded Rear Light Bar with Six 4" Round LED Lights
- Available with 3 3/4" Bolt Pattern, Light Bar Available in Chrome
- Available with Chrome Plastic Light Bezel with Visor (Item # 10483) and Rubber Grommet (Item # 31515)



61746



63775

Item # with Visor	Item # with Grommet	LED Lights				Rear Light Bar			
		4" LED			Item #	LEDs	Lens	Item #	Finish
61746	63746				39924B x 6	7 Red	Red	31616	Chrome
61747	63747				39925B x 6	7 Red	Clear	31616	Chrome
61675	63675				39642B x 6	36 Red	Red	31616	Chrome
61676	63676				39643B x 6	36 Red	Clear	31616	Chrome
61543	63543				38116B x 6	12 Red	Red	31616	Chrome
61544	63544				38117B x 6	12 Red	Clear	31616	Chrome
61545	63545				38770B x 6	10 Red	Red	31616	Chrome
61546	63546				38772B x 6	10 Red	Clear	31616	Chrome
63772	63774				37132 x 6	21 Red	Red	31616	Chrome
63773	63775				37134 x 6	21 Red	Clear	31616	Chrome



Stainless Spring Loaded Rear Light Bar - 3 3/4" Bolt Pattern

DESCRIPTION

- Spring Loaded Rear Light Bar with Six 4" Round LED Lights
- Available with 3 3/4" Bolt Pattern, Light Bar Available in Stainless Steel
- Available with Chrome Plastic Light Bezel with Visor (Item # 10483) and Rubber Grommet (Item # 31515)



Item # with Visor	Item # with Grommet	LED Lights				Rear Light Bar	
		4" LED	Item #	LEDs	Lens	Item #	Finish
61748	63748		39924B x 6	7 Red	Red	22237	304 Stainless
61749	63749		39925B x 6	7 Red	Clear	22237	304 Stainless
61677	63677		39642B x 6	36 Red	Red	22237	304 Stainless
61678	63678		39643B x 6	36 Red	Clear	22237	304 Stainless
61551	63551		38116B x 6	12 Red	Red	22237	304 Stainless
61552	63552		38117B x 6	12 Red	Clear	22237	304 Stainless
61553	63553		38770B x 6	10 Red	Red	22237	304 Stainless
61554	63554		38772B x 6	10 Red	Clear	22237	304 Stainless
63776	63778		37132 x 6	21 Red	Red	22237	304 Stainless
63777	63779		37134 x 6	21 Red	Clear	22237	304 Stainless
61800	63800		39924B x 6	7 Red	Red	22300	430 Stainless
61801	63801		39925B x 6	7 Red	Clear	22300	430 Stainless
61726	63726		39642B x 6	36 Red	Red	22300	430 Stainless
61727	63727		39643B x 6	36 Red	Clear	22300	430 Stainless
61724	63724		38770B x 6	10 Red	Red	22300	430 Stainless
61725	63725		38772B x 6	10 Red	Clear	22300	430 Stainless
63760	63762		37132 x 6	21 Red	Red	22300	430 Stainless
63761	63763		37134 x 6	21 Red	Clear	22300	430 Stainless

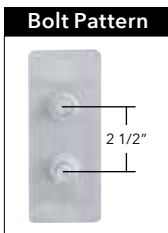

Spring Loaded Rear Light Bar - 2 1/2" Bolt Pattern

DESCRIPTION

- Spring Loaded Rear Light Bar with Six 4" Round LED Lights
- Available with 2 1/2" Bolt Pattern, Light Bar Available in Chrome or Stainless Steel
- Available with Chrome Plastic Light Bezel with Visor (Item # 10483) and Rubber Grommet (Item # 31515)

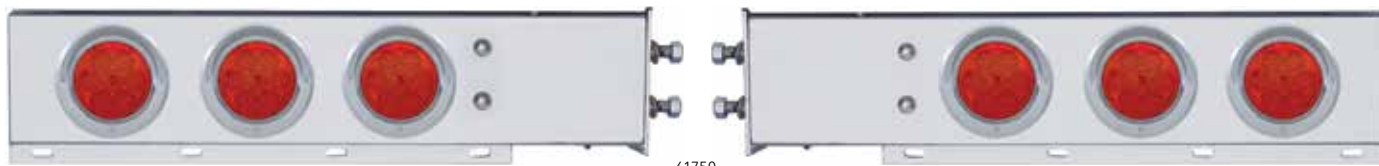

61750

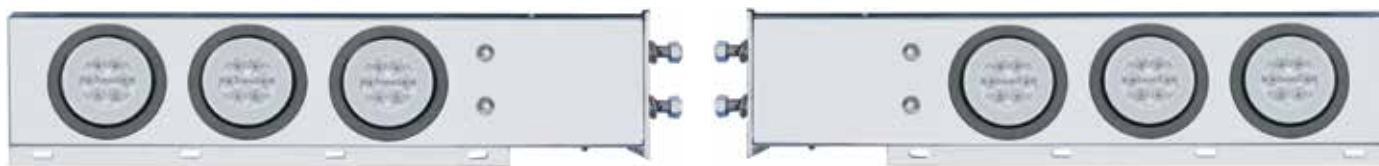

63767

Item # with Visor	Item # with Grommet	LED Lights				Rear Light Bar			
		4" LED			Item #	LEDs	Lens	Item #	Finish
61750	63750				39924B x 6	7 Red	Red	31615	Chrome
61751	63751				39925B x 6	7 Red	Clear	31615	Chrome
61679	63679				39642B x 6	36 Red	Red	31615	Chrome
61680	63680				39643B x 6	36 Red	Clear	31615	Chrome
61643	63643				38116B x 6	12 Red	Red	31615	Chrome
61644	63644				38117B x 6	12 Red	Clear	31615	Chrome
61645	63645				38770B x 6	10 Red	Red	31615	Chrome
61646	63646				38772B x 6	10 Red	Clear	31615	Chrome
63780	63782				37132 x 6	21 Red	Red	31615	Chrome
63781	63783				37134 x 6	21 Red	Clear	31615	Chrome
61802	63802				39924B x 6	7 Red	Red	22301	430 Stainless
61803	63803				39925B x 6	7 Red	Clear	22301	430 Stainless
61728	63728				39642B x 6	36 Red	Red	22301	430 Stainless
61729	63729				39643B x 6	36 Red	Clear	22301	430 Stainless
61730	63730				38770B x 6	10 Red	Red	22301	430 Stainless
61731	63731				38772B x 6	10 Red	Clear	22301	430 Stainless
63764	63766				37132 x 6	21 Red	Red	22301	430 Stainless
63765	63767				37134 x 6	21 Red	Clear	22301	430 Stainless

Spring Loaded Rear Light Bar - 2" Bolt Pattern

DESCRIPTION

- Spring Loaded Rear Light Bar with Six 4" Round LED Lights
- Available with 2" Bolt Pattern, Light Bar Available in Stainless Steel
- Available with Chrome Plastic Light Bezel with Visor (Item # 10483) and Rubber Grommet (Item # 31515)

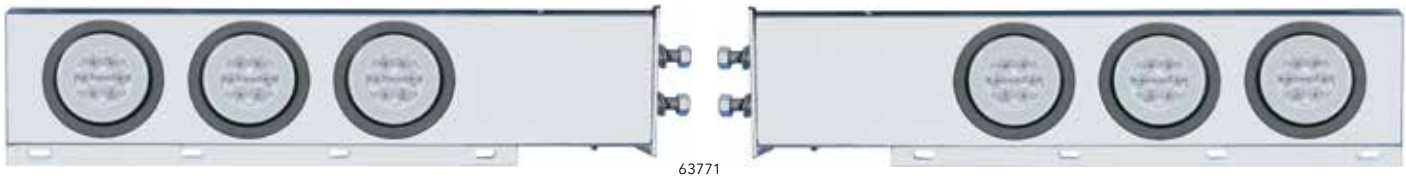
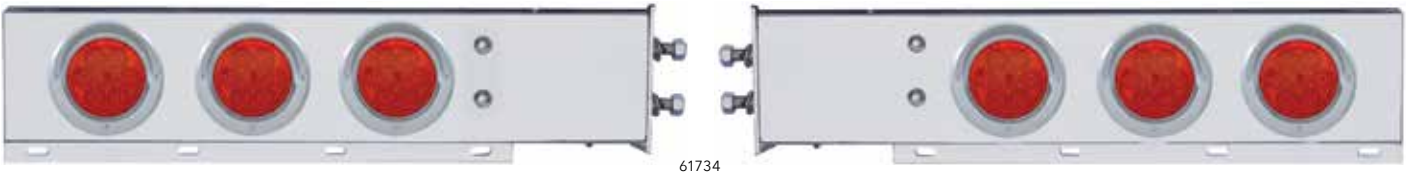
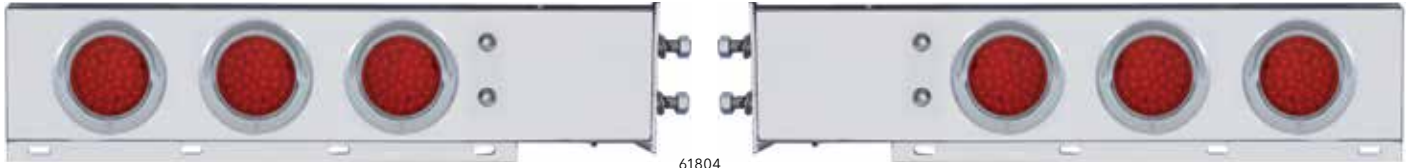

Item # with Visor	Item # with Grommet	LED Lights				Rear Light Bar	
		4" LED	Item #	LEDs	Lens	Item #	Finish
61804	63804		39924B x 6	7 Red	Red	22302	430 Stainless
61805	63805		39925B x 6	7 Red	Clear	22302	430 Stainless
61732	63732		39642B x 6	36 Red	Red	22302	430 Stainless
61733	63733		39643B x 6	36 Red	Clear	22302	430 Stainless
61734	63734		38770B x 6	10 Red	Red	22302	430 Stainless
61735	63735		38772B x 6	10 Red	Clear	22302	430 Stainless
63768	63770		37132 x 6	21 Red	Red	22302	430 Stainless
63769	63771		37134 x 6	21 Red	Clear	22302	430 Stainless



Stainless Spring Loaded Rear Light Bar - 3 3/4" Bolt Pattern

DESCRIPTION

- Spring Loaded Rear Light Bar with Six 6" Oval LED Lights
- Available with 3 3/4" Bolt Pattern, Light Bar Available in Stainless Steel
- Available with Chrome Plastic Light Bezel with Visor (Item # 10489) and Rubber Grommet (Item # 31506)

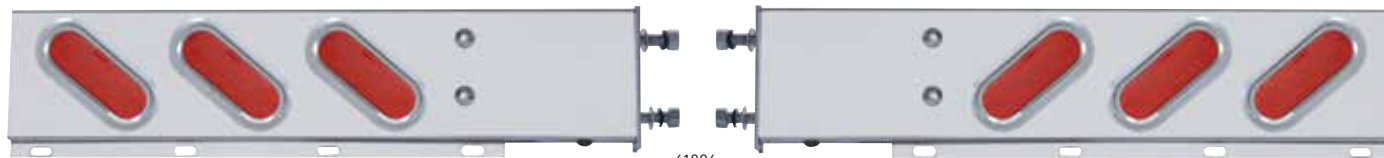

61806

Item # with Visor	Item # with Grommet	LED Lights				Rear Light Bar	
		Oval LED	Item #	LEDs	Lens	Item #	Finish
61806	63806		39703B x 6	19 Red	Red	22303	430 Stainless
61807	63807		39705B x 6	19 Red	Clear	22303	430 Stainless
61302	63302		38121B x 6	12 Red	Red	22303	430 Stainless
61300	63300		38774B x 6	10 Red	Red	22303	430 Stainless
63784	63786		37128B x 6	22 Red	Red	22303	430 Stainless
63785	63787		36924B x 6	22 Red	Clear	22303	430 Stainless

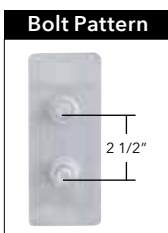

Stainless Spring Loaded Rear Light Bar - 2 1/2" Bolt Pattern

DESCRIPTION

- Spring Loaded Rear Light Bar with Six 6" Oval LED Lights
- Available with 2 1/2" Bolt Pattern, Light Bar Available in Stainless Steel
- Available with Chrome Plastic Light Bezel with Visor (Item # 10489) and Rubber Grommet (Item # 31506)

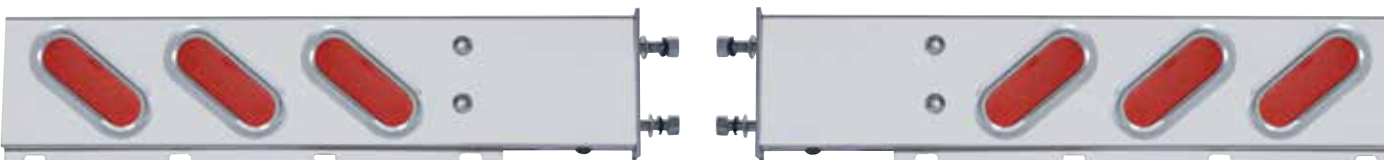

61806

Item # with Visor	Item # with Grommet	LED Lights				Rear Light Bar	
		Oval LED	Item #	LEDs	Lens	Item #	Finish
61306	63306		38121B x 6	12 Red	Red	22304	430 Stainless
61304	63304		38774B x 6	10 Red	Red	22304	430 Stainless
63788	63790		37128B x 6	22 Red	Red	22304	430 Stainless
63789	63791		36924B x 6	22 Red	Clear	22304	430 Stainless

Rear Light Bar - 4" Incandescent Light x 6

DESCRIPTION

- Rear Light Bar with Six 4" Round Incandescent Light, 4 Hole Flange Mount
- Available in Chrome or Stainless Steel, Available with Chrome Plastic Light Bezel w/ Visor (Item # 10483) and Rubber Grommet (Item # 31515)
- 4" Incandescent Light Available Separately (Item # 31109)

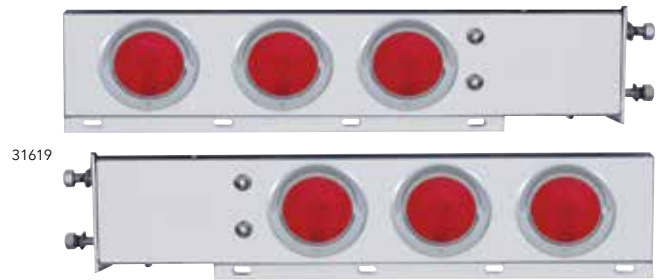
**Spring Loaded Rear Light Bar - 3 3/4" Bolt Pattern**

Item # with Visor	Item # with Grommet	Incandescent Light				Rear Light Bar	
		4" Incandescent Lights	Item #	Type	Lens	Item #	Finish
31619	31617		31109 x 6	Incandescent	Red	31616	Chrome
22240	22238		31109 x 6	Incandescent	Red	22237	304 Stainless
22350	22356		31109 x 6	Incandescent	Red	22300	430 Stainless

Spring Loaded Rear Light Bar - 2 1/2" Bolt Pattern

Item # with Visor	Item # with Grommet	Incandescent Lights				Rear Light Bar	
		4" Incandescent Lights	Item #	Type	Lens	Item #	Finish
31009	31011		31109 x 6	Incandescent	Red	31615	Chrome
22351	22357		31109 x 6	Incandescent	Red	22301	430 Stainless

Spring Loaded Rear Light Bar - 2" Bolt Pattern

Item # with Visor	Item # with Grommet	Incandescent Lights				Rear Light Bar	
		4" Incandescent Lights	Item #	Type	Lens	Item #	Finish
61304	63304		31109 x 6	Incandescent	Red	22302	430 Stainless

Stainless Spring Loaded Rear Light Bar - Oval Incandescent Light x 6

DESCRIPTION

- Spring Loaded Rear Light Bar with Six 6" Oval Incandescent Lights
- Available with 2 1/2" or 3 3/4" Bolt Pattern, Light Bar Available in Stainless Steel
- Available with Chrome Plastic Light Bezel with Visor (Item # 10489) and Rubber Grommet (Item # 31506)

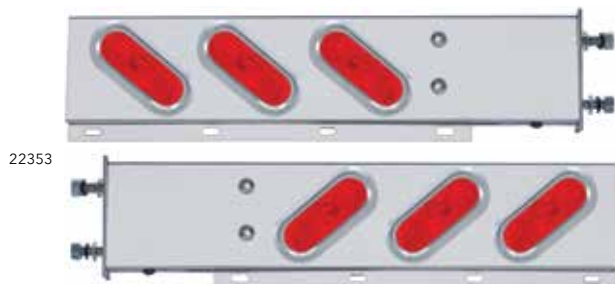
**Spring Loaded Rear Light Bar - 3 3/4" Bolt Pattern**

Item # with Visor	Item # with Grommet	Incandescent Lights				Rear Light Bar	
		4" Incandescent Lights	Item #	Type	Lens	Item #	Finish
22353	22359		31362 x 6	Incandescent	Red	22303	430 Stainless

Spring Loaded Rear Light Bar - 2 1/2" Bolt Pattern

Item # with Visor	Item # with Grommet	Incandescent Lights				Rear Light Bar	
		4" Incandescent Lights	Item #	Type	Lens	Item #	Finish
22354	22360		31362 x 6	Incandescent	Red	22304	430 Stainless

REAR CENTER PANEL

46" Stainless Rear Light Panel - Plain

DESCRIPTION

- 46" x 15 1/2" Stainless Steel Plain Center Rear Light Panel
- Stainless Steel Panel Only

Item #	Description	Package	Pack
21460	Rear Light Panel - Plain	Bulk	1 Pc.

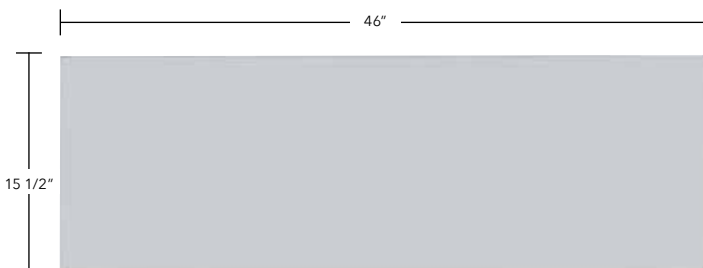

46" Stainless Rear Light Panel - 4" Light Cutout x 11

DESCRIPTION

- 46" x 15 1/2" Stainless Steel Rear Light Panel with Eleven 4" Light Cutouts and Pre-drilled Holes for License Light & Plate
- Stainless Steel Panel Only

Item #	Material	Light Holes	Package	Pack
21462	Stainless	11	Bulk	1 Pc.

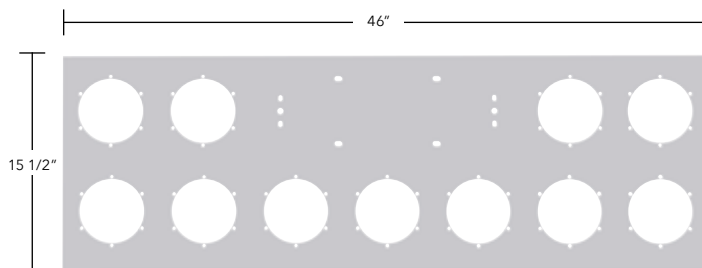

Included Accessories

License Frame 50003 LED License Light 39930B Bullet Fastener 10889

46" Stainless Rear Light Panel - 4" Light x 11

DESCRIPTION

- 46" x 15 1/2" Stainless Steel Rear Center Light Panel with Eleven 4" Round LED Lights
- Includes LED License Light (Item # 39930B x 2), Chrome License Frame (Item # 50003), Bullet Fastener (Item # 10889), and Rubber Grommet (Item # 31515)
- Available with or without Chrome Light Bezel
- Chrome Plastic Light Bezel Available Separately: 4" Light Bezel with Visor (Item # 10483B), 4" Flat Light Bezel (Item # 10484B)
- Stainless Steel Rear Center Panel Available Separately (Item # 21462)



33636

Item # with Visor	Item # with Bezel	Item # with Grommet	4" LED Lights			Rear Center Panel	
			Item #	LEDs	Lens	Item #	Finish
33636	33736	33836	38770B x 11	10 Red	Red	21462	Stainless
33637	33737	33837	38772B x 11	10 Red	Clear	21462	Stainless
33638	33738	33838	38116B x 11	12 Red	Red	21462	Stainless
33639	33739	33839	38117B x 11	12 Red	Clear	21462	Stainless
34596	34696	34796	39924B x 11	7 Red	Red	21462	Stainless
34597	34697	34797	39925B x 11	7 Red	Clear	21462	Stainless

4" LEDs

38770B 38772B 38116B 38117B 39924B 39925B

4" Bezel / Grommet

10483B 10484B 31515

Stainless Rear Center Panel

DESCRIPTION

- 33 3/4" Stainless Steel Rear Center Light Panel with Four 4" Light Cutouts, Six 2" Light Cutouts, and Pre-drilled Holes for License Light and Plate
- Stainless Panel Only, Fits 10 Lights Total, Enclosed Design

Item #	Material	Light Holes	Package	Pack
21493	430 Stainless	10	Boxed	1 Pc./Box

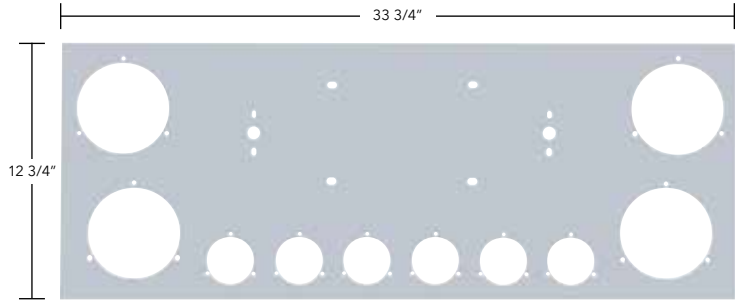

Stainless Rear Center Panel - 4" Light x 4 and 2" Light x 6

DESCRIPTION

- Stainless Steel Rear Center Light Panel with Four 4" LED Lights and Six 2" LED Lights
- 4" LED Lights Available in 3 Different Styles with or without Reflectors in Color or Clear Lens, Now Available with GLO Light
- Includes LED License Light (Item # 39930 x 2), Chrome License Frame (Item # 50003), Bullet Fastener (Item # 10889), and Rubber Grommet (Item # 31515 / 31505), Available with or without Chrome Light Bezel
- Chrome Plastic Light Bezel Available Separately: 2" Light Bezel with Visor (Item # 10481B), 2" Flat Light Bezel (Item # 10458B), 4" Light Bezel with Visor (Item # 10483B), 4" Flat Light Bezel (Item # 10484B)

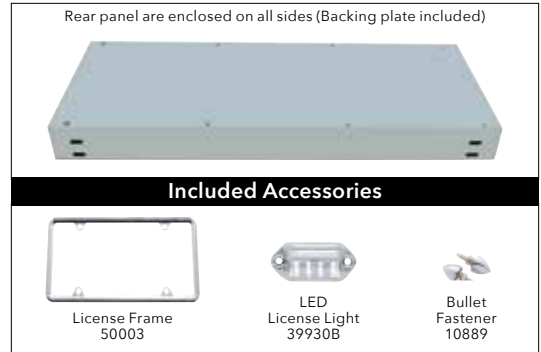

34564

Item # with Visor	Item # with Bezel	Item # w/ Grommet	4" LED Lights			2" LED Lights			Rear Center Panel	
			Item #	LEDs	Lens	Item #	LEDs	Lens	Item #	Finish
34564	34664	34764	38770B x 4	10 Red	Red	38171B x 6	9 Red	Red	21493	Stainless
34565	34665	34765	38772B x 4	10 Red	Clear	38363B x 6	9 Red	Clear	21493	Stainless
34566	34666	34766	39924B x 4	7 Red	Red	38171B x 6	9 Red	Red	21493	Stainless
34567	34667	34767	39925B x 4	7 Red	Clear	38363B x 6	9 Red	Clear	21493	Stainless
34280	-	34480	37132 x 4	21 Red	Red	38171B x 6	9 Red	Red	21493	Stainless

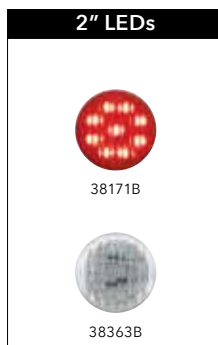

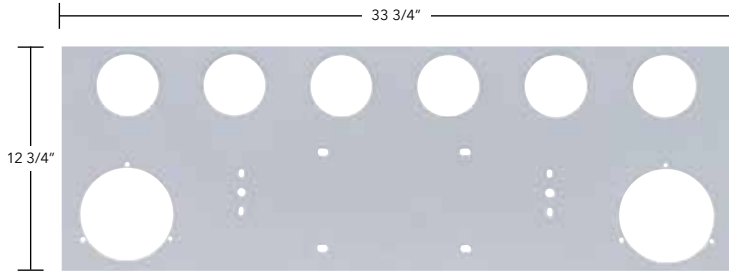

Stainless Rear Center Panel

DESCRIPTION

- 33 3/4" Stainless Steel Rear Center Light Panel with Two 4" Light Cutouts, Six 2 1/2" Light Cutouts, and Pre-drilled Holes for License Light & Plate
- Stainless Panel Only, Fits 8 Lights Total, Enclosed Design
- Back Plate Available Separately (Item # 21589)

Item #	Material	Light Holes	Package	Pack
21478	430 Stainless	8	Boxed	1 Pc./Box

Stainless Rear Center Panel - 4" Light x 2 and 2 1/2" Light x 6

DESCRIPTION

- Stainless Steel Rear Center Light Panel with Two 4" LED Lights and Six 2 1/2" LED Lights
- 4" LED Lights Available in 2 Different Styles with or without Reflectors in Color or Clear Lens
- Includes LED License Light (Item # 39930 x 2), Chrome License Frame (Item # 50003), Bullet Fastener (Item # 10889), and Rubber Grommet (Item # 31515 / 31503), Available with or without Chrome Light Bezel
- Chrome Plastic Light Bezel Available Separately: 2 1/2" Light Bezel with Visor (Item # 10482B), 2 1/2" Flat Light Bezel (Item # 10459B), 4" Light Bezel with Visor (Item # 10483B), 4" Flat Light Bezel (Item # 10484B)

Rear panel are enclosed on all sides (Backing plate included)

Included Accessories

License Frame
50003

LED
License Light
39930B

Bullet
Fastener
10889



35057

Item # with Visor	Item # with Bezel	Item # w/ Grommet	4" LED Lights			2 1/2" LED Lights			Rear Center Panel	
			Item #	LEDs	Lens	Item #	LEDs	Lens	Item #	Finish
35057	35157	35257	38770B x 2	10 Red	Red	38177B x 6	13 Red	Red	21478	Stainless
35058	35158	35258	38772B x 2	10 Red	Clear	38365B x 6	13 Red	Clear	21478	Stainless
35059	35159	35259	39924B x 2	7 Red	Red	38177B x 6	13 Red	Red	21478	Stainless
35060	35160	35260	39925B x 2	7 Red	Clear	38365B x 6	13 Red	Clear	21478	Stainless

4" LEDs	2 1/2" LEDs	4" Bezel / Grommet	2 1/2" Bezel / Grommet
 38770B 39924B 38772B 39925B	 38177B 38365B	 10483B 10484B 31515	 10482B 10459B 31503

Stainless Rear Center Panel

DESCRIPTION

- 33 3/4" Stainless Steel Rear Center Light Panel with Six 4" Light Cutouts and Six 2" Light Cutouts
- Stainless Steel Panel Only, Fits 12 Lights Total, Enclosed Design
- Back Plate Available Separately (Item # 21589)

Item #	Material	Light Holes	Package	Pack
21474	430 Stainless	8	Boxed	1 Pc./Box

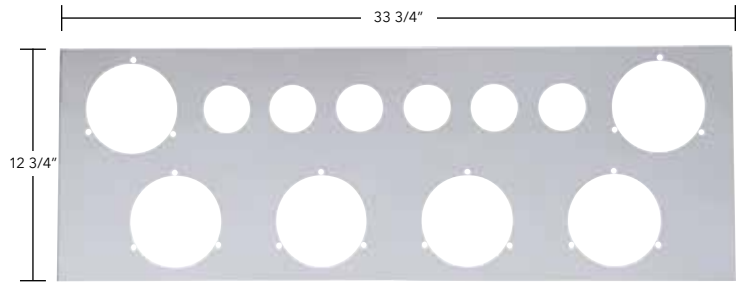

Stainless Rear Center Panel - 4" Light x 6 and 2" Light x 6

DESCRIPTION

- Stainless Steel Rear Center Light Panel with Six 4" LED Lights and Six 2" LED Lights
- 4" LED Lights Available in 3 Different Styles with or without Reflectors in Color or Clear Lens, Now Available in GLO Light
- Chrome Plastic Light Bezel Available Separately: 2" Light Bezel with Visor (Item # 10481B), 2" Flat Light Bezel (Item # 10458B), 4" Light Bezel with Visor (Item # 10483B), 4" Flat Light Bezel (Item # 10484B)

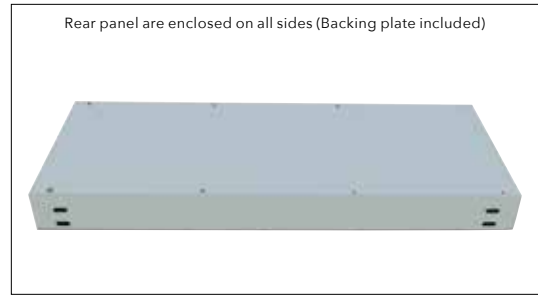

35067

Item # with Visor	Item # with Bezel	Item # w/ Grommet	4" LED Lights			2" LED Lights			Rear Center Panel	
			Item #	LEDs	Lens	Item #	LEDs	Lens	Item #	Finish
35067	35167	35267	38770B x 6	10 Red	Red	38171B x 6	9 Red	Red	21474	Stainless
35068	35168	35268	38772B x 6	10 Red	Clear	38363B x 6	9 Red	Clear	21474	Stainless
35069	35169	35269	39924B x 6	7 Red	Red	38171B x 6	9 Red	Red	21474	Stainless
35070	35170	35270	39925B x 6	7 Red	Clear	38363B x 6	9 Red	Clear	21474	Stainless
35071	35171	35272	37132 x 6	21 Red	Red	38171B x 6	9 Red	Red	21474	Stainless
35072	35172	35273	37134 x 6	21 Red	Clear	38363B x 6	9 Red	Clear	21474	Stainless

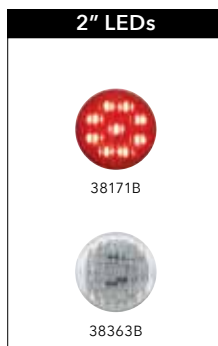

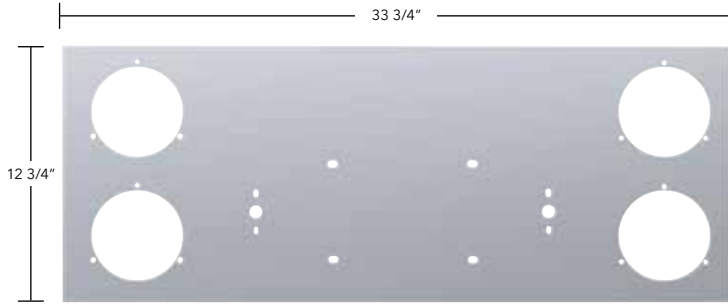

Stainless Rear Center Panel

DESCRIPTION

- 33 3/4" Stainless Steel Rear Center Light Panel with Four 4" Light Cutouts, and Pre-drilled Holes for License Light & Plate
- Stainless Steel Panel Only, Fits 4 Lights Total, Enclosed Design

Item #	Material	Light Holes	Package	Pack
21475	430 Stainless	4	Boxed	1 Pc./Box

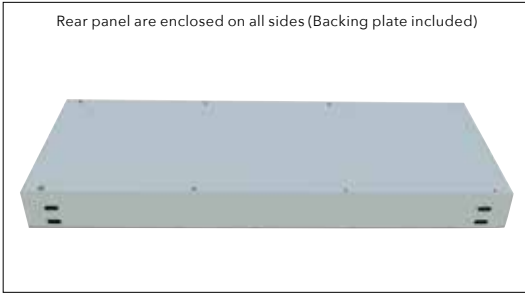

Stainless Rear Center Panel - 4" Light x 4

DESCRIPTION

- Stainless Steel Rear Center Light Panel with Four 4" LED Lights
- 4" LED Lights Available in 3 Different Styles with or without Reflectors in Color or Clear Lens
- Includes LED License Light (Item # 39930 x 2), Chrome License Frame (Item # 50003), Bullet Fastener (Item # 10889), and Rubber Grommet (Item # 31515)
- Chrome Plastic Light Bezel Available Separately: 4" Light Bezel with Visor (Item # 10483B), 4" Flat Light Bezel (Item # 10484B)



35061

Item # with Visor	Item # with Bezel	Item # with Grommet	4" LED Lights			Rear Center Panel	
			Item #	LEDs	Lens	Item #	Finish
35061	35161	35261	38770B x 4	10 Red	Red	21475	Stainless
35062	35162	35262	38772B x 4	10 Red	Clear	21475	Stainless
35063	35163	35263	39924B x 4	7 Red	Red	21475	Stainless
35064	35164	35264	39925B x 4	7 Red	Clear	21475	Stainless
35065	35165	35265	37132 x 4	21 Red	Red	21475	Stainless
35066	35166	35266	37134 x 4	21 Red	Clear	21475	Stainless



Stainless Rear Center Panel

DESCRIPTION

- 33 3/4" Stainless Steel Rear Center Light Panel with Two 4" Light Cutouts, Six 2 1/2" Light Cutouts, and Pre-drilled Holes for License Light & Plate
- Stainless Steel Panel Only, Fits 8 Lights Total

Item #	Material	Light Holes	Package	Pack
21501	Stainless	8	Bulk	1 Pc.

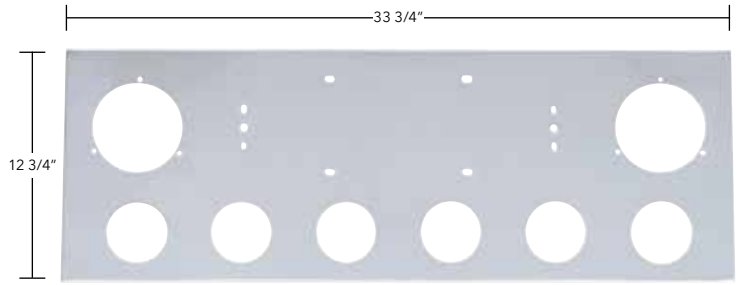

Stainless Rear Center Panel - 4" Light x 2 and 2 1/2" Light x 6

DESCRIPTION

- 34" Stainless Steel Rear Center Light Panel with Two 4" LED or Incandescent Lights and Six 2 1/2" LED or Incandescent Lights
- Includes LED License Light (Item # 39930B x 2), Chrome License Frame (Item # 50003), Bullet Fastener (Item # 10889), and Rubber Grommet (Item # 31515 / 31503)
- Bezels Available Separately: 2 1/2" Bezel with Visor (Item # 10482B), 2 1/2" Flat Bezel (Item # 10459B), 4" Bezel with Visor (Item # 10483B), 4" Flat Bezel (Item # 10484B)

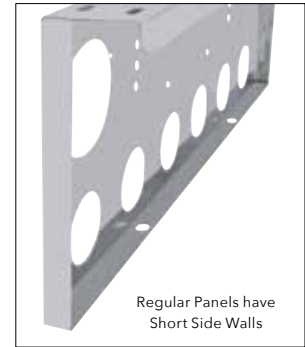

LED Rear Center Panel

35067

Item # with Visor	Item # with Bezel	Item # w/ Grommet	4" LED Lights			2 1/2" LED Lights				Rear Center Panel Item #
			Item #	LEDs	Lens	Item #	LEDs	Lens	Style	
33681	33781	33881	38770B x 2	10 Red	Red	38177B x 6	13 Red	Red	Flat	21501
33682	33782	33882	38770B x 2	10 Red	Red	38179B x 6	13 Red	Red	Beehive	21501
33683	33783	33883	38772B x 2	10 Red	Clear	38365B x 6	13 Red	Clear	Flat	21501
33685	33785	33885	38116B x 2	12 Red	Red	38177B x 6	13 Red	Red	Flat	21501
33686	33786	33886	38116B x 2	12 Red	Red	38179B x 6	13 Red	Red	Beehive	21501
33687	33787	33887	38117B x 2	12 Red	Clear	38365B x 6	13 Red	Clear	Flat	21501
35112	35212	35312	39924B x 2	7 Red	Red	38177B x 6	13 Red	Red	Flat	21501
35113	35213	35313	39925B x 2	7 Red	Clear	38365B x 6	13 Red	Clear	Flat	21501

Incandescent Rear Center Panel

Item # with Visor	Item # with Bezel	Item # w/ Grommet	4" Incandescent Lights			2 1/2" Incandescent Lights				Rear Center Panel Item #
			Item #	Type	Lens	Item #	Type	Lens	Style	
21653	21654	21656	31109 x 2	Incandescent	Red	31065 x 6	Incandescent	Red	Flat	21501
21512	21655	21502	31109 x 2	Incandescent	Red	30168 x 6	Incandescent	Red	Beehive	21501



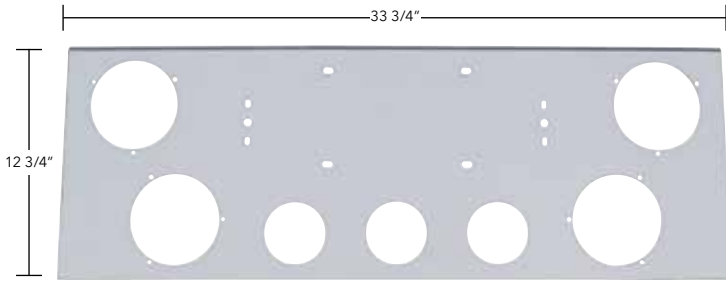

Stainless Rear Center Panel

DESCRIPTION

- 33 3/4" Stainless Steel Rear Center Light Panel with Four 4" Light Cutouts, Three 2 1/2" Light Cutouts, and Pre-drilled Holes for License Light & Plate
- Stainless Steel Panel Only, Fits 7 Lights Total

Item #	Material	Light Holes	Package	Pack
21495	Stainless	7	Bulk	1 Pc.

Stainless Deluxe Rear Center Panel - 4" Light x 4 and 2 1/2" Light x 3

DESCRIPTION

- 34" Stainless Steel Rear Center Light Panel with Four 4" LED or Incandescent Lights and Three 2 1/2" LED or Incandescent Lights
- Includes LED License Light (Item # 39930B x 2), Chrome License Frame (Item # 50003), Bullet Fastener (Item # 10889), and Rubber Grommet (Item # 31515 / 31503)
- Bezel Available Separately: 2 1/2" Bezel with Visor (Item # 10482B), 2 1/2" Flat Bezel (Item # 10459B), 4" Bezel with Visor (Item # 10483B), 4" Flat Bezel (Item # 10484B)

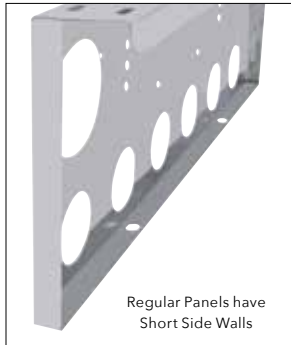

34500

LED Rear Center Panel

Item # with Visor	Item # with Bezel	Item # w/ Grommet	4" LED Lights			2 1/2" LED Lights				Rear Center Panel Item #
			Item #	LEDs	Lens	Item #	LEDs	Lens	Style	
34500	34600	34700	38770B x 4	10 Red	Red	38177B x 3	13 Red	Red	Flat	21495
34501	34601	34701	38770B x 4	10 Red	Red	38179B x 3	13 Red	Red	Beehive	21495
34502	34602	34702	38772B x 4	10 Red	Clear	38365B x 3	13 Red	Clear	Flat	21495
34504	34604	34704	38116B x 4	12 Red	Red	38177B x 3	13 Red	Red	Flat	21495
34505	34605	34705	38116B x 4	12 Red	Red	38179B x 3	13 Red	Red	Beehive	21495
34506	34606	34706	38117B x 4	12 Red	Clear	38365B x 3	13 Red	Clear	Flat	21495
34562	34662	34762	39924B x 4	7 Red	Red	38177B x 3	13 Red	Red	Flat	21495
34563	34663	34763	39925B x 4	7 Red	Clear	38365B x 3	13 Red	Clear	Flat	21495

Incandescent Rear Center Panel

Item # with Visor	Item # with Bezel	Item # w/ Grommet	4" Incandescent Lights			2 1/2" Incandescent Lights				Rear Center Panel Item #
			Item #	Type	Lens	Item #	Type	Lens	Style	
21608	21609	21612	31109 x 4	Incandescent	Red	31065 x 3	Incandescent	Red	Flat	21495
21499	21611	21496	31109 x 4	Incandescent	Red	31068 x 3	Incandescent	Clear	Beehive	21495



Chrome Rear Center Panel

DESCRIPTION

- 33 3/4" Chrome Rear Center Light Panel with Four 4" Light Cutouts, Three 2 1/2" Light Cutouts, and Pre-drilled Holes for License Light and Plate
- Chrome Panel Only, Fits 7 Lights Total
- Back Plate Not Available on Curved Series

Item #	Material	Light Holes	Package	Pack
31595	Chrome	7	Bulk	1 Pc.

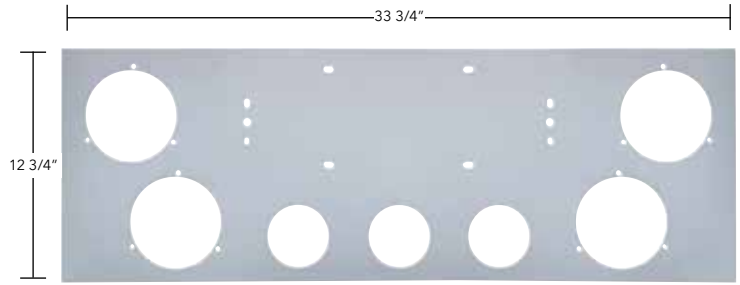

Chrome Deluxe Rear Center Panel - 4" Light x 4 and 2 1/2" Light x 3

DESCRIPTION

- 34" Chrome Steel Rear Center Light Panel with Four 4" LED or Incandescent Lights and Three 2 1/2" LED or Incandescent Lights
- Includes LED License Light (Item # 39930B x 2), Chrome License Frame (Item # 50003), Bullet Fastener (Item # 10889), and Rubber Grommet (Item # 31515 / 31503)
- Bezel Available Separately: 2 1/2" Bezel with Visor (Item # 10482B), 2 1/2" Flat Bezel (Item # 10459B), 4" Bezel with Visor (Item # 10483B), 4" Flat Bezel (Item # 10484B)

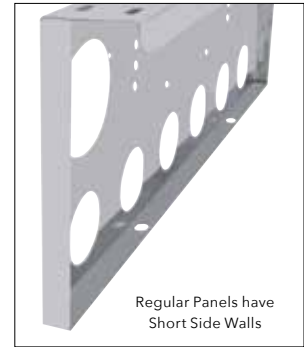

LED Rear Center Panel

34508

Item # with Visor	Item # with Bezel	Item # w/ Grommet	4" LED Lights			2 1/2" LED Lights				Rear Center Panel Item #
			Item #	LEDs	Lens	Item #	LEDs	Lens	Style	
34508	34608	34708	38770B x 4	10 Red	Red	38177B x 3	13 Red	Red	Flat	31595
34509	34609	34709	38770B x 4	10 Red	Red	38179B x 3	13 Red	Red	Beehive	31595
34510	34610	34710	38772B x 4	10 Red	Clear	38365B x 3	13 Red	Clear	Flat	31595
34512	34612	34712	38116B x 4	12 Red	Red	38177B x 3	13 Red	Red	Flat	31595
34513	34613	34713	38116B x 4	12 Red	Red	38179B x 3	13 Red	Red	Beehive	31595
34514	34614	34714	38117B x 4	12 Red	Clear	38365B x 3	13 Red	Clear	Flat	31595
35118	35218	35318	39924B x 4	7 Red	Red	38177B x 3	13 Red	Red	Flat	31595
35119	35219	35319	39925B x 4	7 Red	Clear	38365B x 3	13 Red	Clear	Flat	31595

Incandescent Rear Center Panel

Item # with Visor	Item # with Bezel	Item # w/ Grommet	4" Incandescent Lights			2 1/2" Incandescent Lights				Rear Center Panel Item #
			Item #	Type	Lens	Item #	Type	Lens	Style	
21653	21654	21656	31109 x 4	Incandescent	Red	31065 x 3	Incandescent	Red	Flat	31595
21512	21655	21502	31109 x 4	Incandescent	Red	31068 x 3	Incandescent	Clear	Beehive	31595

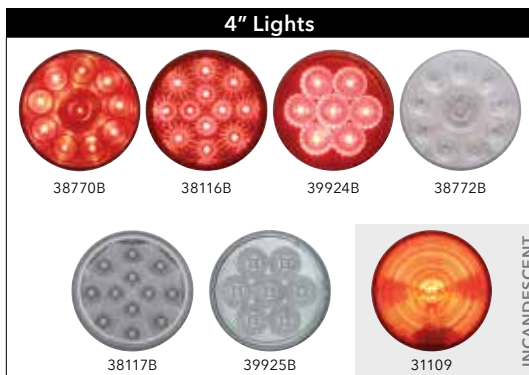

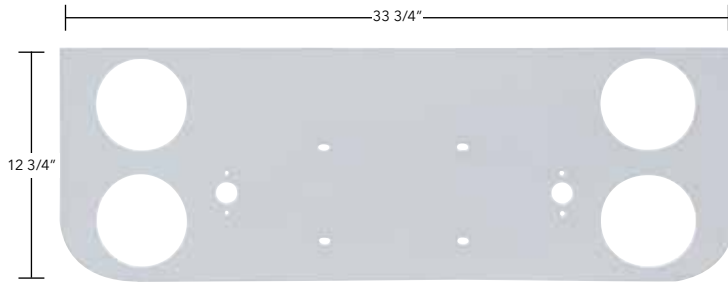

Chrome Rear Center Panel

DESCRIPTION

- 33 3/4" Rear Center Light Panel with Four 4" Light Cutouts, Holes for License Light & Plate
- Back Plate Not Available on Curved Series

Item #	Material	Light Holes	Package	Pack
30208	Chrome	4	Bulk	1 Pc.

Chrome Rear Center Panel - 4" Light x 4

DESCRIPTION

- 34" Chrome Rear Center Light Panel with Four 4" LED or Incandescent Lights
- Includes LED License Light (Item # 39930B x 2), Chrome License Frame (Item # 50003), Bullet Fastener (Item # 10889), and Rubber Grommet (Item # 31515)
- Chrome Plastic Light Bezel Available Separately: 4" Light Bezel with Visor (Item # 10483B), 4" Flat Light Bezel (Item # 10484B)
- Rear Center Panel Available Separately in Chrome or Stainless Steel: Chrome Rear Panel (Item # 30208), Stainless Steel Rear Panel (Item # 21560)



LED Rear Center Panel

Item # with Visor	Item # with Bezel	Item # with Grommet	4" LED Lights			Rear Center Panel	
			Item #	LEDs	Lens	Item #	Finish
34520	34620	34720	38770B x 4	10 Red	Red	30208	Chrome
34521	34621	34721	38772B x 4	10 Red	Clear	30208	Chrome
34522	34622	34722	38116B x 4	12 Red	Red	30208	Chrome
34523	34623	34723	38117B x 4	12 Red	Clear	30208	Chrome
35122	35222	35322	39924B x 4	7 Red	Red	30208	Chrome
35123	35223	35323	39925B x 4	7 Red	Clear	30208	Chrome

Incandescent Rear Center Panel

Item # with Visor	Item # with Bezel	Item # with Grommet	4" Incandescent Lights			Rear Center Panel	
			Item #	Type	Lens	Item #	Finish
31601	21437	30209	31109 x 4	Incandescent	Red	30208	Chrome

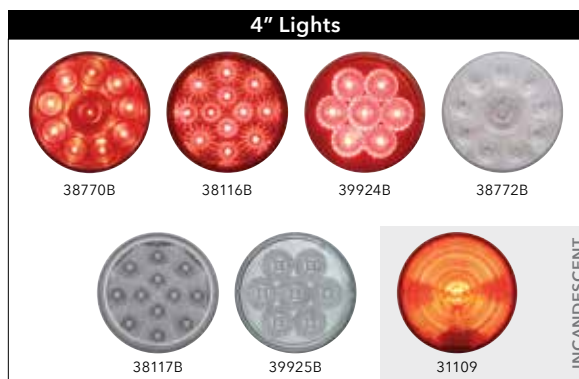

Chrome Rear Center Panel

DESCRIPTION

- 33 3/4" Rear Center Light Panel with 4 Rectangular Light Cutouts and Pre-drilled Holes for License Light & Plate
- Available in Chrome or Stainless Steel Panel Only, Fits 4 Lights Total
- Back Plate Not Available on Curved Series

Item #	Material	Light Holes	Package	Pack
30221	Chrome	4	Bulk	1 Pc.

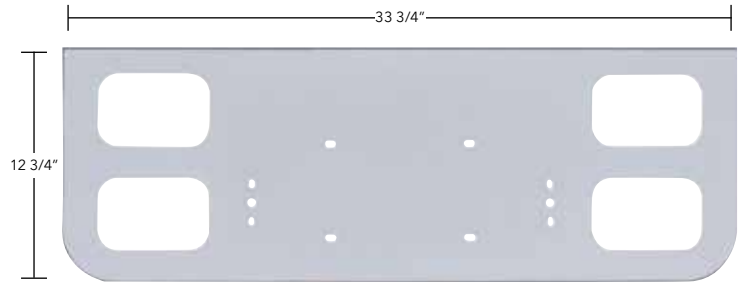

Rear Center Panel - Rectangular Light x 4

DESCRIPTION

- 34" Rear Center Light Panel with 4 Rectangular LED or Incandescent Lights
- Includes LED License Frame, Chrome License Frame (Item # 50003), Bullet Fastener (Item # 10889), and Rubber Grommet (Item # 31516)
- Available with or without Chrome Light Bezel
- Chrome Plastic Light Bezel Available Separately: Rectangular Light Bezel with Visor (Item # 10485B), Rectangular Flat Light Bezel (Item # 10499B)
- Rear Center Panel Available Separately: Chrome Rear Panel (Item # 30221)



30223



Regular Panels have Short Side Walls

LED Rear Center Panel

Item # with Visor	Rectangular LED			Rear Center Panel	
	Item#	LEDs	Lens	Item #	Finish
34559	38747B x 4	15 Red	Red	30221	Chrome
34560	38749B x 4	15 Red	Clear	30221	Chrome

Incandescent Rear Center Panel

Item # with Visor	Item # with Grommet	Rectangular Incandescent		Rear Center Panel	
		Item #	Lens	Item #	Finish
30223	30222	31364 x 4	Red	30221	Chrome

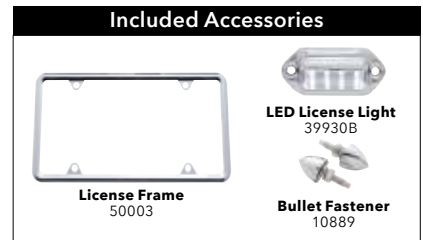



MUD FLAP HANGER

MUD FLAP HANGER



Chrome



Stainless



Black



End Cap

30" Spring Loaded Mud Flap Hanger - 2 1/2" Bolt Pattern

Item #	Bolt Center	Finish	End Cap	Pack
10653	2 1/2"	Chrome	Open	1 Pair
10654	2 1/2"	304 Stainless	Open	1 Pair
10841	2 1/2"	430 Stainless	Open	1 Pair
10655	2 1/2"	Black	Open	1 Pair

30" Spring Loaded Mud Flap Hanger - 2" Bolt Pattern

Item #	Bolt Center	Finish	End Cap	Pack
10668	2"	Chrome	Open	1 Pair
10669	2"	304 Stainless	Open	1 Pair
10842	2"	430 Stainless	Open	1 Pair
10670	2"	Black	Open	1 Pair

30" Spring Loaded Mud Flap Hanger - 1 1/8" Bolt Pattern

Item #	Bolt Center	Finish	End Cap	Pack
10836	1 1/8"	Chrome	Open	1 Pair
10843	1 1/8"	430 Stainless	Open	1 Pair
10838	1 1/8"	Black	Open	1 Pair

30" Spring Loaded Mud Flap Hanger

DESCRIPTION

- 30" Heavy Duty Spring Loaded Mud Flap Hanger
- Stainless Steel End Plug Available Separately: Item # 20611
- Available in Stainless Steel, Chrome, or Black Painted Finish
- Available with 2 1/2", 2", or 1 1/8" Bolt Pattern



Chrome



Stainless



End Cap

30" Spring Loaded Mud Flap Hanger - 2 1/2" Bolt Pattern

Item #	Bolt Center	Finish	End Cap	Pack
10697	2 1/2"	Chrome	Open	1 Pair
10660	2 1/2"	304 Stainless	Open	1 Pair
10849	2 1/2"	430 Stainless	Open	1 Pair

30" Spring Loaded Mud Flap Hanger - 2" Bolt Pattern

Item #	Bolt Center	Finish	End Cap	Pack
10850	2"	430 Stainless	Open	1 Pair

30" Spring Loaded Mud Flap Hanger - 1 1/8" Bolt Pattern

Item #	Bolt Center	Finish	End Cap	Pack
10833	1 1/8"	Chrome	Open	1 Pair
10834	1 1/8"	304 Stainless	Open	1 Pair

30" Spring Loaded Mud Flap Hanger - Reflector

DESCRIPTION

- 30" Heavy Duty Spring Loaded Mud Flap Hanger with Conspicuity Reflector
- Stainless Steel End Plug Available Separately: Item # 20611
- Available in Stainless Steel, Chrome, or Black Painted Finish

30" Spring Loaded Mud Flap Hanger - Competition Series

DESCRIPTION

- 30" Heavy Duty Spring Loaded Mud Flap Hanger, Competition Series
- Available in 430 Stainless Steel, Chrome, or Black Painted Finish
- Stainless Steel End Plug Available Separately: Item # 20611

Item #	Bolt Center	Finish	End Cap	Pack
11300	2 1/2"	Chrome	Open	1 Pair/Box
11310	2 1/2"	Stainless	Open	1 Pair/Box
11320	2 1/2"	Black	Open	1 Pair/Box



Chrome



Stainless



Black



COMPETITION
SERIES

30" Spring Loaded Mud Flap Hanger - Light Duty

DESCRIPTION

- 30" Light Duty Spring Loaded Mud Flap Hanger, Capped End
- Available in Chrome, Stainless Steel, or Black Finish

Item #	Bolt Center	Finish	End Cap	Pack
10656	1 1/8"	Chrome	Capped	1 Pair
10687	1 1/8"	Stainless	Capped	1 Pair
10686	1 1/8"	Black	Capped	1 Pair



30" Spring Loaded Mud Flap Hanger w/ Welded End Cap

DESCRIPTION

- 30" Heavy Duty Spring Loaded Mud Flap Hanger
- Includes Welded End Cap Plug
- 2 1/2" Bolt Pattern

Item #	Bolt Center	Finish	End Cap	Pack
10712	2 1/2"	Black	Closed	1 Pair/Box



30" Spring Loaded Mud Flap Hanger - Light Duty

DESCRIPTION

- 30" Light Duty Spring Loaded Mud Flap Hanger, Open End
- Available in Chrome or Stainless Steel

Item #	Bolt Center	Finish	End Cap	Pack
10648	1 1/8"	Chrome	Open	1 Pair
10647	1 1/8"	304 Stainless	Open	1 Pair



Recommended Accessories

Quarter Fender/Mud Flap Hanger Display

DESCRIPTION

- Quarter Fender/Mud Flap Hanger Display

Item #	Description	Package	Pack
99068	Quarter Fender/Mud Flap Hanger Display	Boxed	1 Set/Box



30" Spring Loaded Mud Flap Hanger - Light End Cap

DESCRIPTION

- 30" Heavy Duty Spring Loaded Mud Flap Hanger with Light End Cap
- End Cap Bracket Fit any 2" Round Light

Item #	Bolt Center	Finish	End Cap	Pack
10639	2 1/2"	Chrome	Light Bracket	1 Pair



30" Chrome Spring Loaded Mud Flap Hanger - LED End Cap

DESCRIPTION

- 30" Heavy Duty Chrome Spring Loaded Mud Flap Hanger with LED End Cap
- LED End Cap Available with 2 Different Style of 2" LED Light
- Chrome Plastic Light Bezel Available Separately: 2" Light Bezel with Visor (Item # 10481B), 2" Flat Light Bezel (Item # 10458B)
- Hanger End Light Bracket Available Separately: Item # 10667



65000



66001

Item # with Visor	Item # with Bezel	Item # w/ Grommet	LED Lights						Hanger		
			2" LED	Item #	LEDs	Lens	Reflector	Item #	Finish		
65000	66000	67000				38170B	9 Amber	Amber	No	10639	Chrome
65001	66001	67001				38171B	9 Red	Red	No	10639	Chrome
65002	66002	67002				38362B	9 Amber	Clear	No	10639	Chrome
65003	66003	67003				38363B	9 Red	Clear	No	10639	Chrome
65004	66004	67004				38849B	9 Amber	Amber	Yes	10639	Chrome
65005	66005	67005				38850B	9 Red	Red	Yes	10639	Chrome
65006	66006	67006				38851B	9 Amber	Clear	Yes	10639	Chrome
65007	66007	67007				38852B	9 Red	Clear	Yes	10639	Chrome

30" Spring Loaded Mud Flap Hanger - 45° Angled

DESCRIPTION

- 30" Heavy Duty Spring Loaded Mud Flap Hanger, 45° Angled
- Available in Stainless Steel, Chrome, or Black Painted Finish

30" Spring Loaded Mud Flap Hanger - 2 1/2" Bolt Pattern

Item #	Bolt Center	Finish	End Cap	Pack
10643	2 1/2"	Chrome	Closed	1 Pair
10645	2 1/2"	304 Stainless	Closed	1 Pair
10846	2 1/2"	430 Stainless	Closed	1 Pair
10674	2 1/2"	Black	Closed	1 Pair

30" Spring Loaded Mud Flap Hanger - 2" Bolt Pattern

Item #	Bolt Center	Finish	End Cap	Pack
10684	2"	Chrome	Open	1 Pair
10685	2"	304 Stainless	Open	1 Pair
10847	2"	430 Stainless	Open	1 Pair

30" Spring Loaded Mud Flap Hanger - 1 1/8" Bolt Pattern

Item #	Bolt Center	Finish	End Cap	Pack
10649	1 1/8"	Chrome	Open	1 Pair
10652	1 1/8"	430 Stainless	Open	1 Pair
10650	1 1/8"	Black	Open	1 Pair



Chrome

Stainless

Black

End Cap

Bolt Pattern

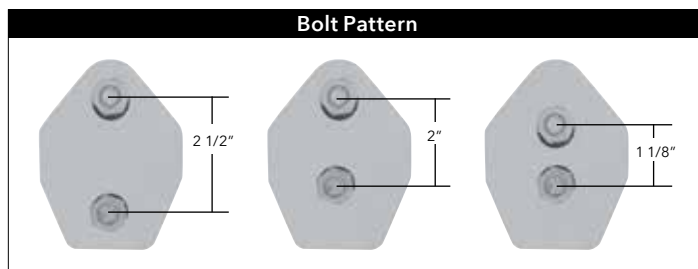

28" Spring Loaded Mud Flap Hanger - 45° Angled

DESCRIPTION

- 28" Spring Loaded Mud Flap Hanger, 45° Angled
- Available in Chrome, Capped End

Item #	Bolt Center	Finish	End Cap	Pack
10651	1 1/8"	Chrome	Capped	1 Pair

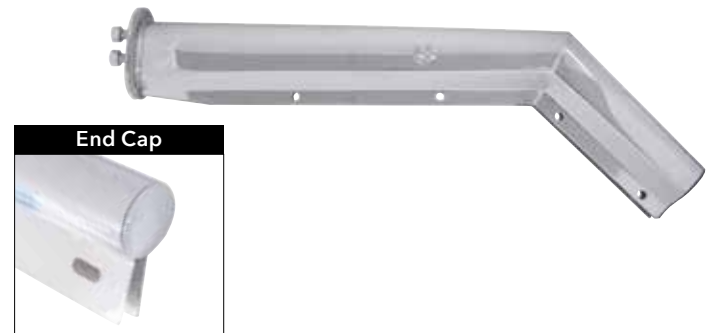

End Cap

28" Spring Loaded Mud Flap Hanger - 45° Angled

DESCRIPTION

- 28" Spring Loaded Mud Flap Hanger, 45° Angled
- Available in Chrome, Capped End

Item #	Bolt Center	Finish	End Cap	Pack
10646	1 1/8"	Chrome	Capped	1 Pair
10681	1 1/8"	Black	Capped	1 Pair

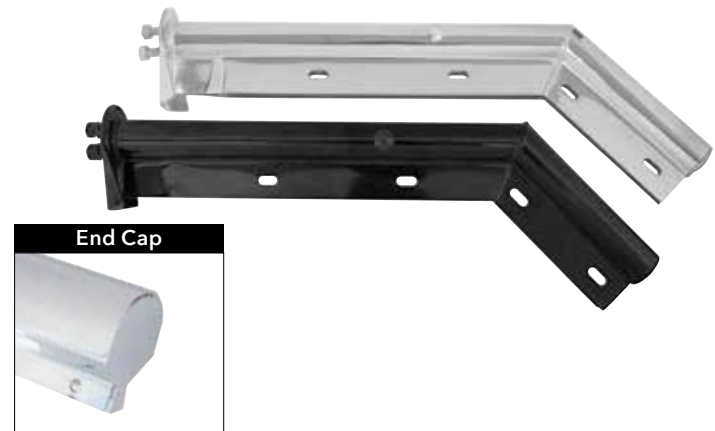

End Cap

28" Spring Loaded Mud Flap Hanger - 45° Angled

DESCRIPTION

- 28" Spring Loaded Mud Flap Hanger, 45° Angled, Competition Series
- Available in Chrome, Capped End

Item #	Bolt Center	Finish	End Cap	Pack
10860	1 1/8"	Chrome	Capped	1 Pair/Box
10861	1 1/8"	Black	Capped	1 Pair/Box



COMPETITION
SERIES

Black Straight Mud Flap Hanger

DESCRIPTION

- Black Straight Mud Flap Hanger, 0.64" Square Spring Steel Arm
- Available in Black Primer Finish, Approximately 29 3/4" Long
- Adjustable Clips and Bolts Included
- Sold: Bulk = 1 Pair

Item #	Square	Coil	Package	Pack
10671	0.64"	-	Bulk	1 Pair
10625	0.64"	1 Coil	Bulk	1 Pair
10626	0.64"	2 Coil	Bulk	1 Pair
10627	0.64"	3 Coil	Bulk	1 Pair



10671



10625



10626



10627

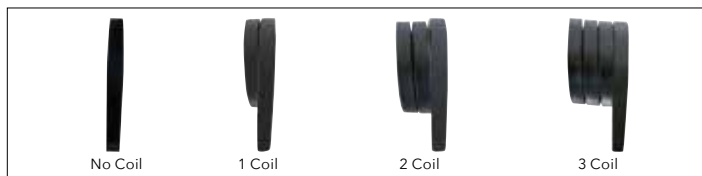

No Coil

1 Coil

2 Coil

3 Coil

Standard Cast Mount

DESCRIPTION

- Standard Cast Mount for Mud Flap Hangers
- Black Primer, One-Piece Mount
- Holds 0.64" Square Mud Flap Arm
- Sold: Bulk = 1 Pc.

Item #	Description	Square	Pack
89001	Standard Cast Mount	0.64"	1 Pc.

**Black Angled Mud Flap Hanger**

DESCRIPTION

- Black Angled Mud Flap Hanger, 0.64" Square Spring Steel Arm
- Available in Black Primer Finish, Approximately 28" Long
- Adjustable Clips and Bolts Included
- Sold: Bulk = 1 Pair

Item #	Square	Coil	Package	Pack
10672	0.64"	-	Bulk	1 Pair
10613	0.64"	1 Coil	Bulk	1 Pair
10614	0.64"	2 Coil	Bulk	1 Pair
10615	0.64"	3 Coil	Bulk	1 Pair



10672



10613



10614



10615

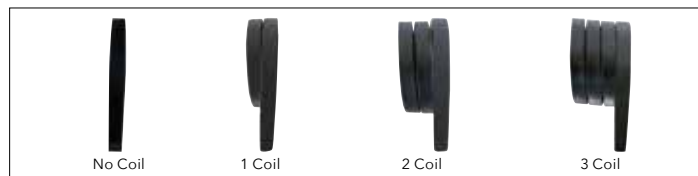

No Coil

1 Coil

2 Coil

3 Coil

Spring Loaded Hanger Accessories**Replacement Spring**

DESCRIPTION

- Replacement Spring for Spring Loaded Mud Flap Hanger
- Available in Bulk Only
- Only for Single Spring Series Hangers

Item #	Description	Package	Pack
10638	Replacement Spring	Bulk	1 Pc.





Conspicuity Reflector Plate - Straight

DESCRIPTION

- Aluminum Conspicuity Reflector Plate for Straight Mud Flap Hanger

Item #	Description	Package	Pack
10601	Straight Reflector Plate	Carded	1 Pair/Card

Conspicuity Reflector Plate - 45° Angled

DESCRIPTION

- Aluminum Conspicuity Reflector Plate for Angled Mud Flap Hanger

Item #	Description	Package	Pack
10602	Straight Reflector Plate	Carded	1 Pair/Card



Conspicuity Reflector Plate Light Housing

DESCRIPTION

- Conspicuity Reflector Plate Light Housing for 6 1/2" LED Light Bar
- Housing Only, Available in Red or Clear Lens
- Slides into UP Conspicuity Reflector Plates (Item # 10601 & 10602)

Item #	Lens	Package	Pack
30890B	Red	Bulk	1 Pc.
30891B	Clear	Bulk	1 Pc.



LED Conspicuity Reflector Plate Light

DESCRIPTION

- 10 LED Conspicuity Reflector Plate Light with 6 1/2" LED Light Bar
- Slides into UP Conspicuity Reflector Plates (Item # 10601 & 10602)
- Proper Installation Requires Drilling Holes in the Aluminum Plate for Wire Exits
- 6 1/2" Ten Red LED Light Bar Available in Red or Clear Lens

Item #	Reflector Lens Color	LED Lights		
		LEDs	Lens	Item #
37166	Red	10 Red	Red	39685B
37167	Red	10 Red	Clear	39687B
37168	Clear	10 Red	Red	39685B
37169	Clear	10 Red	Clear	39687B



37166



37167



37168



37169



Stainless Mud Flap Hanger End Plug

DESCRIPTION

- Stainless Steel Hanger End Plug
- Cover the End Opening on Spring Loaded Mud Flap Hangers

Item #	Description	Package	Pack
20611	Stainless End Plug	Bulk	1 Pc.
20611P	Stainless End Plug	Carded	2 Pcs./Card

**Chrome Mud Flap Hanger End Plug**

DESCRIPTION

- Chrome 2" Fender Pipe End Plug, Fits 2" Outer Diameter Pipe
- Cover the End Opening on Spring Loaded Mud Flap Hangers

Item #	Description	Package	Pack
10441	Chrome 2" End Plug	Bulk	1 Pc.
10441P	Chrome 2" End Plug	Carded	2 Pcs./Card

**Chrome Mud Flap Hanger End Light Bracket**

DESCRIPTION

- Chrome Universal Mud Flap Hanger End Light Bracket
- Bracket Only, Fits 2" Round Light
- Grommet Needed for Light Installation, Grommet Sold Separately

Item #	Description	Package	Pack
10667	Hanger End Light Bracket	Bulk	1 Pc.

**Chrome Mud Flap Hanger End Light**

DESCRIPTION

- Chrome Universal Mud Flap Hanger End Light
- Available with 2" LED or Incandescent Light
- End Light Bracket Available Separately: Item # 10667

LED Flap Hanger End Light

Item # with Visor	Item # w/ Grommet	LED Lights		
		Style	LEDs	Lens
10980	10990	Flat	9 Amber	Amber
10981	10991	Flat	9 Red	Red
10982	10992	Flat	9 Amber	Clear
10983	10993	Flat	9 Red	Clear
10984	10994	Beehive	9 Amber	Amber
10985	10995	Beehive	9 Red	Red
10986	10996	Beehive	9 Amber	Clear
10987	10997	Beehive	9 Red	Clear

Incandescent Flap Hanger End Light

Item # with Visor	Item # w/ Grommet	Incandescent Lights		Bracket
		Style	Lens	
10988	10998	Flat	Amber	10667
10677	10675	Beehive	Amber	10667



As Installed

Chrome Mud Flap Hanger End Light - Round

DESCRIPTION

- Chrome Round Mud Flap Hanger End Light
- 2" Diameter End Plug Fits Peterbilt Spring Loaded Mud Flap Hanger
- Available with Incandescent Beehive Light Only

Item #	Plug Size	Fits	Light Color	Pack
10665	2"	Peterbilt	Amber	1 Pc./Card

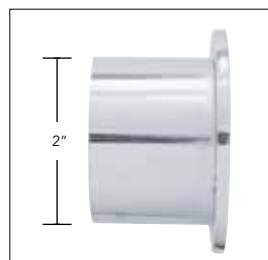

10665



Chrome Mud Flap Hanger End Light - Round

DESCRIPTION

- Chrome Round Mud Flap Hanger End Light Bracket
- 1 5/8" End Plug Fits Kenworth Spring Loaded Mud Flap Hanger
- 2" End Plug Fits Peterbilt Spring Loaded Mud Flap Hanger
- Bracket Only, No Light Included

Item #	Description	Package	Pack
10661-1	1 5/8" Dia. for Kenworth	Bulk	1 Pc.
10665-1	2" Dia. for Peterbilt	Bulk	1 Pc.

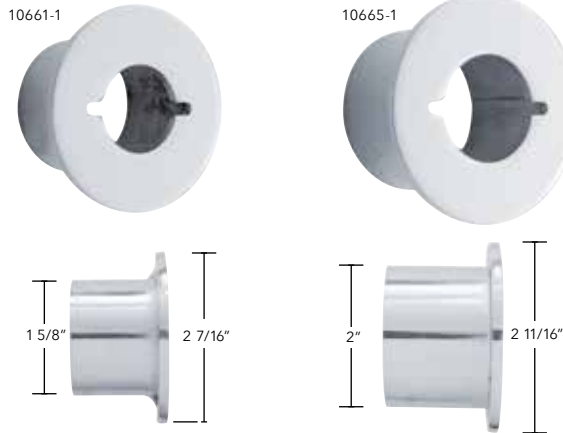

Reflexite® Reflector Tape

DESCRIPTION

- Reflector Tape with Alternating Red and White Pattern Provided with the DOT-C2 Certification Marks as Per NHTSA 9CFR571.108
- Tape is 2" Wide, Supplied in 150' Roll

Item #	Roll Pattern / Roll Length	Package	Pack
90610	7" White / 11" Red	150'	1 Roll/Box
90611	6" White / 6" Red	150'	1 Roll/Box



ANTI-SAIL BRACKET/PLATE

Anti-Sail Bracket

DESCRIPTION

- Straight Anti-Sail Bracket
- Keep Mud Flaps Secure, Reduce Wear and Tear
- Available in Chrome/Stainless and Various Sizes, Sold: Bulk = 1 Pc.

Item #	Material	Width	Height	Case Qty.
10451	Chrome	24"	21"	20/Case
10451C	Chrome	24"	21"	20/Case
10452	Chrome	24"	18"	10/Case
10453	Chrome	18"	18"	20/Case
10454	Chrome	17 1/2"	8"	10/Case
22451	Stainless	24"	21"	20/Case
22452	Stainless	24"	18"	20/Case

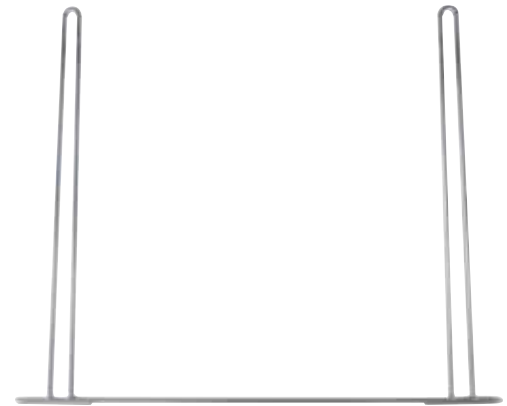

Anti-Sail Bracket - 2" Bottom Plate

DESCRIPTION

- Straight Anti-Sail Bracket with 2" Bottom Plate
- Keep Mud Flaps Secure, Reduce Tear and Wear
- Available in Chrome or Stainless Steel, Sold: Bulk = 1 Pc.

Item #	Material	Width	Height	Case Qty.
10447	Chrome	24"	21"	10/Case
22453	Stainless	24"	21"	10/Case

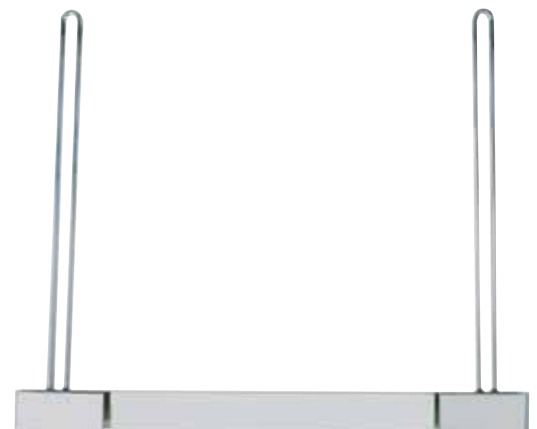

Anti-Sail Bracket - Angled

DESCRIPTION

- Chrome Anti-Sail Bracket for 45° Angled Rear Mud Flap Hanger
- Keep Mud Flaps Secure, Reduce Tear and Wear
- Left and Right Side Available Individually, Also Available in Pairs (UP Item # 10456)

Item #	Material	Side	Width	Case Qty.
10456	Chrome	L&R (Pair)	24"	-
10456L	Chrome	Left Only	24"	10/Case
10456R	Chrome	Right Only	24"	10/Case

**Anti-Sail Bracket - Front Fender**

DESCRIPTION

- Chrome Anti-Sail Bracket for Front Fender Mud Flap
- Keep Mud Flaps Secure, Reduce Tear and Wear, Sold: Bulk = 1 Pc.

Item #	Material	Width	Height	Case Qty.
10457	Chrome	16 1/2"	10 1/4"	20/Case

**Anti-Sail Bracket - Peterbilt Battery Box**

DESCRIPTION

- Straight Anti-Sail Bracket with 2" Bottom Plate
- Keep Mud Flaps Secure, Reduce Tear and Wear
- Available in Chrome or Stainless Steel, Sold: Bulk = 1 Pc.

Peterbilt Battery Box Anti-Sail Bracket

Item #	Material	Width	Height	Case Qty.
10520	Chrome	24"	9"	20/Case

Peterbilt Battery Box Anti-Sail Bracket - 2" Bottom Plate

Item #	Material	Width	Height	Case Qty.
10446	Chrome	24"	9"	10/Case

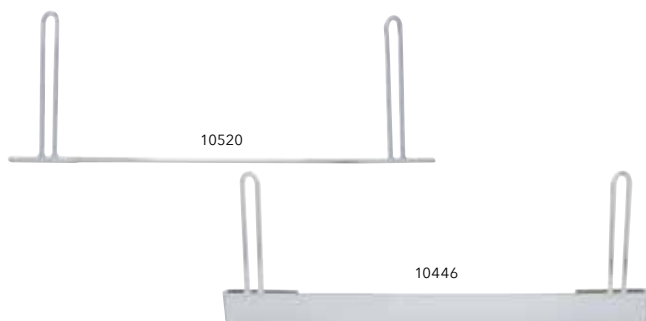
**Stainless Anti-Sail Plate**

DESCRIPTION

- Stainless Steel Anti-Sail Plate
- Prevent Mud Flaps from Whipping and Sailing
- Sold in Pairs

Item #	Material	Width	Louvered	Pack
21430	Stainless	16 1/4"	No	1 Pair
21431	Stainless	16 1/4"	Yes	1 Pair

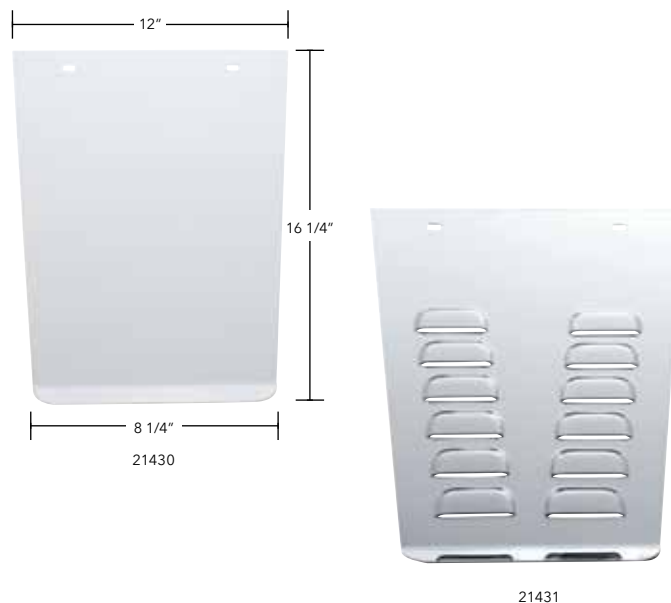
**What's HOT****Chrome Spike Gearshift Knob**

DESCRIPTION

- Chrome Spike Gearshift Knob, CNC-Machined Grip
- Fits 13/18 Speed Gearshift Knobs
- Mounting Adapter (UP Item # 70600B), "Daytona" Spike Grip (UP Item # 70601B) & "Talladega" Spike Grip (UP Item # 70621B) Available Separately
- **Patent Pending**

Item #	Description	Speed	Pack
70607	"Daytona" Gearshift Knob	13/18	1 Pc./Box
70627	"Talladega" Gearshift Knob	13/18	1 Pc./Box



TOP MUD FLAP LIGHT BRACKET/WEIGHT

Stainless Top Mud Flap Light Bracket - 4" Light Cutout

DESCRIPTION

- Stainless Top Mud Flap Light Bracket with Three 4" Light Cutouts
- Each Light Bracket has Three 4" Light Cutouts, Fits 3 Lights Total

Item #	Material	Light Holes	Package	Pack
10640	Stainless	3	Bulk	1 Pc.

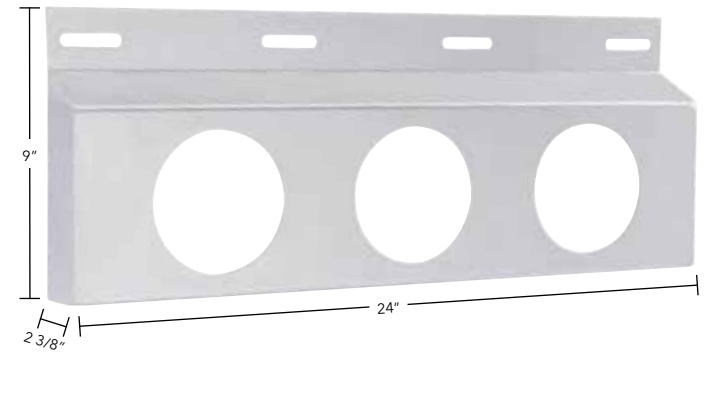

61758



63758



61761

Stainless Top Mud Flap Light Bracket - 4" Light x 3

DESCRIPTION

- Stainless Steel Top Mud Flap Light Bracket with Three 4" LED or Incandescent Lights
- Available with Chrome Bezel with Visor (Item # 10483) and Rubber Grommet (Item # 31515)

Stainless LED Top Mud Flap Light Bracket

Item # with Visor	Item # with Grommet	LED Lights				Light Bracket	
		4" LED	Item #	LEDs	Lens	Item #	Finish
61758	63758		39924B x 3	7 Red	Red	10640	Stainless
61759	63759		39925B x 3	7 Red	Clear	10640	
61702	63702		39642B x 3	36 Red	Red	10640	Stainless
61703	63703		39643B x 3	36 Red	Clear	10640	
61704	63704		38116B x 3	12 Red	Red	10640	Stainless
61705	63705		38117B x 3	12 Red	Clear	10640	
61706	63706		38770B x 3	10 Red	Red	10640	Stainless
61707	63707		38772B x 3	10 Red	Clear	10640	
61760	61960		37132 x 3	21 Red	Red	10640	Stainless
61761	61961		37134 x 3	21 Red	Clear	10640	

Stainless Incandescent Top Mud Flap Light Bracket

Item # with Visor	Item # with Grommet	Incandescent Lights			Light Bracket		
		4" Incandescent	Item #	Type	Lens	Item #	Finish
10644	10641		31109 x 4	Incandescent	Red	10640	Stainless



61708



63708



61709

Stainless Top Mud Flap Light Bracket - Oval Light Cutout

DESCRIPTION

- Stainless Steel Top Mud Flap Light Bracket, 3 Oval Light Cutouts
- Each Light Bracket has 3 Oval Light Cutouts, Fits 3 Lights Total

Item #	Material	Light Holes	Package	Pack
10657	Stainless	3	Bulk	1 Pc.

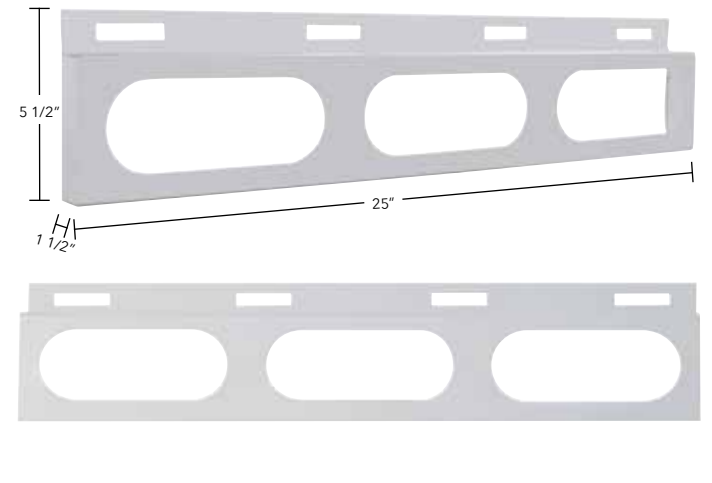















Stainless Top Mud Flap Light Bracket - Oval Light x 3

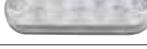

DESCRIPTION

- Stainless Steel Top Mud Flap Light Bracket with Three Oval LED or Incandescent Lights
- Available with Chrome Bezel with Visor (Item # 10489) and Rubber Grommet (Item # 31506)

Stainless LED Top Mud Flap Light Bracket

Item # with Visor	Item # with Grommet	LED Lights				Light Bracket	
		Oval LED	Item #	LEDs	Lens	Item #	Finish
61708	63708	 	38095B x 3	60 Red	Red	10657	Stainless
61709	63709		38319B x 3	60 Red	Clear	10657	Stainless
61710	63710	 	39703B x 3	19 Red	Red	10657	Stainless
61711	63711		39705B x 3	19 Red	Clear	10657	Stainless
61712	63712	 	38121B x 3	12 Red	Red	10657	Stainless
61713	63713		38122B x 3	12 Red	Clear	10657	Stainless
61714	63714	 	38774B x 3	10 Red	Red	10657	Stainless
61715	63715		38776B x 3	10 Red	Clear	10657	Stainless
63792	63794	 	37128B x 3	22 Red	Red	10657	Stainless
63793	63795		36924B x 3	22 Red	Clear	10657	Stainless

Stainless Incandescent Top Mud Flap Light Bracket

Item # with Visor	Item # with Grommet	Incandescent Lights				Light Bracket	
		Oval Incandescent	Item #	Type	Lens	Item #	Finish
10658	10659	 	31362 x 3	Incandescent	Red	10657	Stainless

Stainless Top Mud Flap Light Bracket - 2" Light Cutout

DESCRIPTION

- Stainless Top Mud Flap Light Bracket with Five 2" Light Cutouts
- Each Light Bracket has Five 2" Light Cutouts, Fits 5 Lights Total

Item #	Material	Light Holes	Package	Pack
21397	Stainless	5	Bulk	1 Pc.

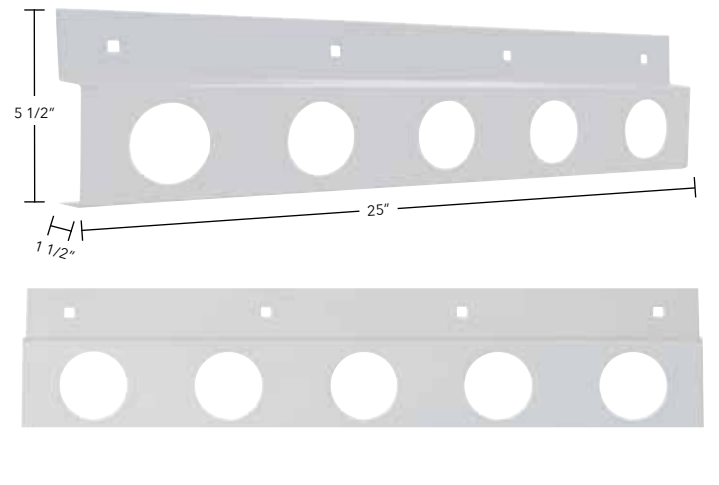

61716



63716



61717

Stainless Top Mud Flap Light Bracket - 2" Light x 5

DESCRIPTION

- Stainless Steel Top Mud Flap Light Bracket with Five 2" LED Lights
- Available with Chrome Bezel with or without Visor (Item # 10481/10458) and Rubber Grommet (Item # 31505)

Stainless LED Top Mud Flap Light Bracket

Item # with Visor	Item # w/ Grommet	LED Lights					Light Bracket	
		2" LED	Item #	LEDs	Lens	Style	Item #	Finish
61716	63716		38171B x 5	9 Red	Red	Flat	21397	Stainless
61717	63717		38363B x 5	9 Red	Clear	Flat	21397	
61718	63718		38850B x 5	9 Red	Red	Flat	21397	Stainless
61719	63719		38852B x 5	9 Red	Clear	Flat	21397	
61720	63720		38411B x 5	9 Red	Red	Flat	21397	Stainless
61721	63721		38413B x 5	9 Red	Clear	Flat	21397	
61722	63722		38169B x 5	9 Red	Red	Beehive	21397	Stainless
61723	63723		38367B x 5	9 Red	Clear	Beehive	21397	
63796	63797		37036B x 5	6 Red	Red	Flat	21397	Stainless

Stainless Incandescent Top Mud Flap Light Bracket

Item # with Visor	Item # w/ Grommet	Incandescent Lights				Light Bracket		
		2" Incandescent	Item #	Type	Lens	Style	Item #	Finish
21400	21398		31109 x 5	Incandescent	Red	Flat	21397	Stainless
21393	21391		30918 x 5	Incandescent	Red	Beehive	21397	Stainless



21385



21353



21365

Stainless Top Mud Flap Light Bracket - 2" Light Cutout

DESCRIPTION

- Stainless Steel Top Mud Flap Light Bracket, 3 Universal Light Cutouts
- Each Light Bracket has 3 Universal Light Cutouts, Fits 3 Lights Total
- Fits Various Rectangular Clearance / Marker Lights

Item #	Material	Light Holes	Package	Pack
21381	Stainless	3	Bulk	1 Pc.

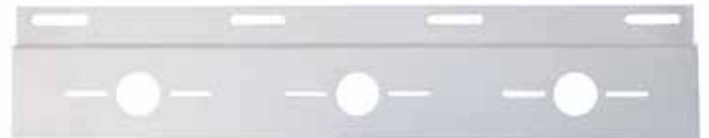
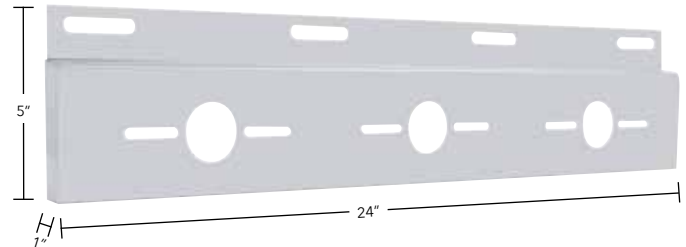

Stainless Top Mud Flap Light Bracket - LED Clearance/Marker Light × 3

DESCRIPTION

- Stainless Steel Top Mud Flap Light Bracket with 3 Rectangular LED Clearance Marker Lights
- LED Rectangular Clearance/Marker Light Available in Various Styles

Item #	LED Clearance/Marker Lights					Light Bracket	
	LED	Item #	LEDs	Lens	Style	Item #	Finish
21385		38285B × 3	16 Red	Red	Phantom I	21381	Stainless
21348		38287B × 3	16 Red	Clear	Phantom I	21381	Stainless
21384		38231B × 3	12 Red	Red	Phantom I	21381	Stainless
21349		38234B × 3	12 Red	Clear	Phantom I	21381	Stainless
21353		39399B × 3	4 Red	Red	Reflector	21381	Stainless
21354		39401B × 3	4 Red	Clear	Reflector	21381	Stainless
21360		39452B × 3	10 Red	Red	Rectangular	21381	Stainless
21361		39454B × 3	10 Red	Clear	Rectangular	21381	Stainless
21364		38257B × 3	21 Red	Red	Turtle Back	21381	Stainless
21365		38297B × 3	21 Red	Clear	Turtle Back	21381	Stainless
21366		39402B × 3	10 Red	Red	Cat's Eye	21381	Stainless
21367		39404B × 3	10 Red	Clear	Cat's Eye	21381	Stainless

Stainless Top Mud Flap Light Bracket - 17" Light Cutout

DESCRIPTION

- Stainless Steel Top Mud Flap Light Bracket, 17" LED Light Bar Cutout
- Fits United Pacific 11 LED 17" Light Bar (Item # 38469B and 38470B)

Item #	Material	Light Holes	Package	Pack
21396	Stainless	1	Bulk	1 Pc.

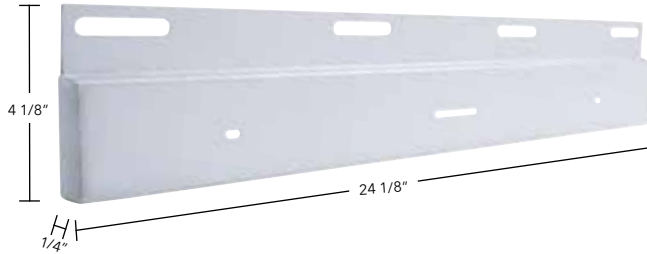

Stainless Top Mud Flap Light Bracket - 9" Light Bar x 4

DESCRIPTION

- Stainless Steel Top Mud Flap Light Bracket, Four 9" Light Bar Cutout
- Fits United Pacific 10 LED 9" Light Bar (Item # 38943B and 38945B)

Item #	Material	Light Holes	Package	Pack
21370B	Stainless	4	Bulk	1 Pc.

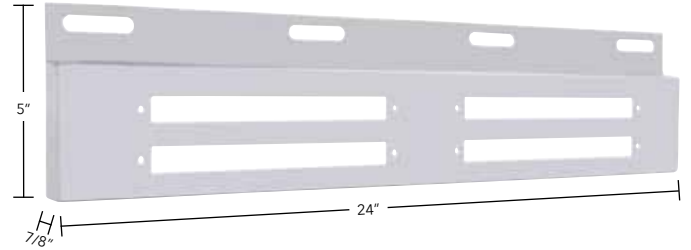

Stainless Top Mud Flap Light Bracket - 11 LED 17" Light Bar x 1

DESCRIPTION

- Stainless Steel Top Mud Flap Light Bracket with 11 LED 17" Light Bar
- Available with or without Chrome Bezel, Chrome Bezel Available Separately: Item # 34047B



21422



21428

Item #	LED Light Bar			
	LED Lights	LED	Lens	Bezel
21422	38469B	11 Red	Red	-
21424	38470B	11 Red	Clear	-
21426	39251B	11 Red	Red	34047B
21428	39253B	11 Red	Clear	34047B

Stainless Top Mud Flap Light Bracket - 10 LED 9" Light Bar x 4

DESCRIPTION

- Stainless Steel Top Mud Flap Light Bracket with Four 10 LED 9" Light Bar



21372



21374

Item #	LED Light Bar			Light Bracket
	LED Lights	LED	Lens	
21372	38943B x 4	10 Red	Red	21370B
21374	38945B x 4	10 Red	Clear	21370B

LED Light Bar



38469B



38470B



39251B



39253B

LED Light Bar



38943B



38945B

Chrome Top Mud Flap Plate - LED Light Bar Cutouts

DESCRIPTION

- 2" x 24" Chrome Top Mud Flap Plate with LED Light Bar Cutouts
- Stud Mounted, Available with 1, 2, or 4 Light Cut Outs

Item #	Description	Cutouts	Pack
10389	LED Top Mud Flap Plate	2	Bulk = 1 Pc.
10390	LED Top Mud Flap Plate	4	Bulk = 1 Pc.
10399	LED Top Mud Flap Plate	1	Bulk = 1 Pc.

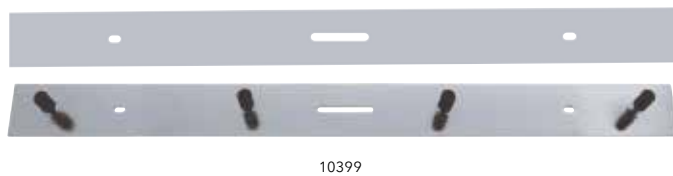
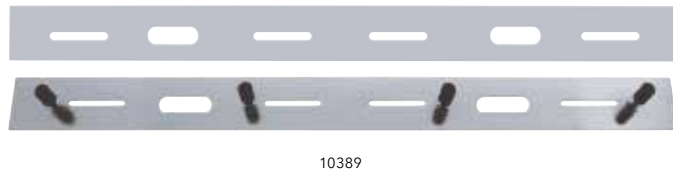
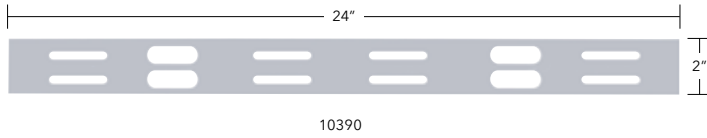
**23 LED Chrome Top Mud Flap Plate**

DESCRIPTION

- Chrome Top Plate with 23 LED Light Bar, Stud Mounted
- LED Light Bar with Amber or Red LED in Colored/Clear Lens
- Stainless Steel Top Plate Available Separately: Item # 10399
- Chrome Plastic Bezel Available Separately: Item # 34059B
- Sold: Bulk = 1 Piece

Item #	17 1/4" LED Light Bar			
	LED bar	LED	Lens	Bezel
20865	37089B	23 Amber	Amber	-
20866	37090B	23 Red	Red	-
20867	37091B	23 Amber	Clear	-
20868	37092B	23 Red	Clear	-
37318	37089B	23 Amber	Amber	34059B
37319	37090B	23 Red	Red	34059B
37320	37091B	23 Amber	Clear	34059B
37321	37092B	23 Red	Clear	34059B

**11 LED Chrome Top Mud Flap Plate**

DESCRIPTION

- Chrome Top Plate with 11 LED Light Bar, Stud Mounted
- LED Light Bar with Amber or Red LED in Colored/Clear Lens
- Stainless Steel Top Plate Available Separately: Item # 10399
- Chrome Plastic Bezel Available Separately: Item # 34047B
- Sold: Bulk = 1 Piece

Item #	17" LED Light Bar			
	LED bar	LED	Lens	Bezel
10395	38463B	11 Amber	Amber	-
10396	38469B	11 Red	Red	-
10397	38464B	11 Amber	Clear	-
10398	38470B	11 Red	Clear	-
10391	38463B	11 Amber	Amber	34047B
10392	38469B	11 Red	Red	34047B
10393	38464B	11 Amber	Clear	34047B
10394	38470B	11 Red	Clear	34047B

**28 LED "GLO" Light Chrome Top Mud Flap Plate**

DESCRIPTION

- Chrome Top Plate with 28 LED GLO Light Bar, Stud Mounted
- LED Light Bar with Red LED in Colored/Clear Lens
- Unique Patent Pending "GLO" Design
- GLO Effect on Running, All LEDs Lit on Stop
- Stainless Steel Top Plate Available Separately: Item # 10399
- Chrome Plastic Bezel Available Separately: Item # 34047B
- Sold: Bulk = 1 Piece

Item #	17" LED Light Bar			
	LED bar	LED	Lens	Bezel
63792	37080	28 Red	Red	-
63793	37082	28 Red	Clear	-
63794	37080	28 Red	Red	34047B
63795	37082	28 Red	Clear	34047B



LED Chrome Top Mud Flap Plate - LED Light Bar x 2

DESCRIPTION

- Chrome Top Plate with Two 14, 19, or 24 LED Light Bar, Stud Mounted
- LED Light Bar with Red LED in Colored, Chrome or Clear Lens
- 24" Stainless Steel Top Plate Available Separately: Item # 10389
- Sold: Bulk = 1 Set, Complete with Lights

Item #	LEDs	Lens	12" Light Bar	Reflector
37105	14 Red	Red	38947B x 2	No
37106	14 Red	Clear	38949B x 2	No
37107	14 Red	Chrome	39645B x 2	No
37108	19 Red	Red	39774B x 2	Yes
37109	19 Red	Clear	39776B x 2	Yes
63812	24 Red	Red	36862B x 2	No
63813	24 Red	Clear	36864B x 2	No



37105



37109



63812

LED Chrome Top Mud Flap Plate - 24" LED Light Bar x 4

DESCRIPTION

- Chrome Top Plate with Four 14, 19, or 24 LED Light Bar, Stud Mounted
- LED Light Bar with Red LED in Colored, Chrome or Clear Lens
- 24" Stainless Steel Top Plate Available Separately: Item # 10390
- Sold: Bulk = 1 Set, Complete with Lights

Item #	LEDs	Lens	12" Light Bar	Reflector
37110	14 Red	Red	38947B x 4	No
37111	14 Red	Clear	38949B x 4	No
37112	14 Red	Chrome	39645B x 4	No
37113	19 Red	Red	39774B x 4	Yes
37114	19 Red	Clear	39776B x 4	Yes
63814	24 Red	Red	36862B x 4	No
63815	24 Red	Clear	36864B x 4	No



37110



37114



63814

LED Chrome Top Mud Flap Plate - LED Light Bar x 2

DESCRIPTION

- Chrome Top Plate with Two 14, 19, or 24 LED Light Bar, Stud Mounted
- LED Light Bar with Red LED in Colored, Chrome, or Clear Lens
- Stainless Steel Top Plate Available Separately: Item # 10389
- Sold: Bulk = 1 Piece

Item #	12" LED Light Bar			
	LED bar	LED	Lens	Reflector
37217	38947B x 2	14 Red	Red	No
37218	38949B x 2	14 Red	Clear	No
37219	39645B x 2	14 Red	Chrome	No
37220	39774B x 2	19 Red	Red	Yes
37221	39776B x 2	19 Red	Clear	Yes
63808	36862B x 2	24 Red	Red	No
63809	36864B x 2	24 Red	Clear	No



37217



63808

LED Chrome Top Mud Flap Plate - LED Light Bar x 4

DESCRIPTION

- Chrome Top Plate with Four 14, 19 or 24 LED Light Bar, Stud Mounted
- LED Light Bar Available with Red LED in Colored, Chrome or Clear Lens
- Stainless Steel Top Plate Available Separately: Item # 10390
- Sold: Bulk = 1 Piece

Item #	12" LED Light Bar			
	LED bar	LED	Lens	Reflector
37222	38947B x 4	14 Red	Red	No
37223	38949B x 4	14 Red	Clear	No
37224	39645B x 4	14 Red	Chrome	No
37225	39774B x 4	19 Red	Red	Yes
37226	39776B x 4	19 Red	Clear	Yes
63810	36862B x 4	24 Red	Red	No
63811	36864B x 4	24 Red	Clear	No



37222



63810

TOP MUD FLAP PLATE/WEIGHT

Top Mud Flap Plate - Plain

DESCRIPTION

- Top Plate for Mud Flaps
- Available in Chrome or Stainless Steel, Mounting Hardware Included
- Item with Item # Ending with "C" Denotes Economy Version
- Sold: Bulk = 1 Piece

Chrome Item #	Stainless Item #	Size	Mounting Stud	Case Quantity
10401	21407 (304 SS)	2" x 24"	Welded Stud	20/Case
10401C	-	2" x 24"	Welded Stud	20/Case
10402	21408 (304 SS)	2" x 24"	Bolt Thru	20/Case
10402C	21432 (430 SS)	2" x 24"	Bolt Thru	20/Case
10404	-	2" x 20"	Bolt Thru	20/Case



Top Mud Flap Plate - Louvered

DESCRIPTION

- Louvered Top Plates for Mud Flaps
- Available in Chrome or Stainless Steel, Mounting Hardware Included
- Sold: Bulk = 1 Piece

Chrome Item #	Stainless Item #	Size	Mounting Stud	Case Quantity
10400	20209	2" x 24"	Bolt Thru	20/Case

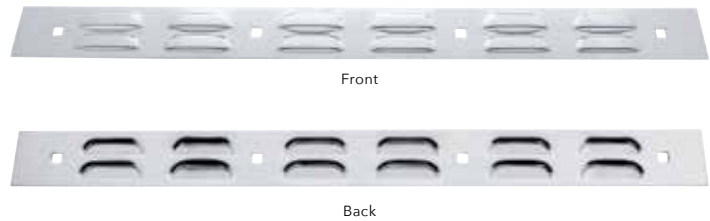

Top Mud Flap Plate Hardware

DESCRIPTION

- Top Plate Replacement Hardware
- Welded Stud Top Plate Hardware Kit Includes: 4 Nuts and 4 Washer
- Bolt Thru Top Plate Hardware Kit Includes: 4 Bolts, 4 Nuts, 4 Washer, and 4 Rubber Inserts

Item #	Description	Pack
10401HW	Hardware for Welded Stud Top Plate	Bulk = 1 Kit
10403	Hardware for Bolt Thru Top Plate	Bulk = 1 Kit

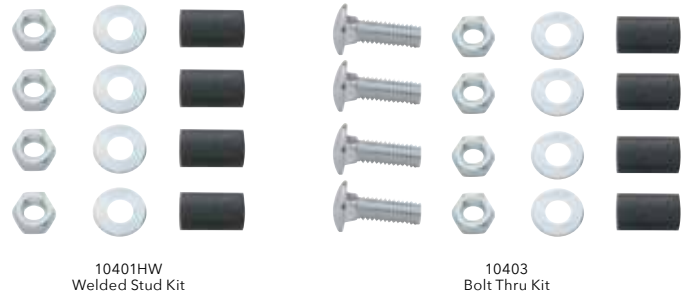

BOTTOM MUD FLAP PLATE/WEIGHT

Flame Bottom Plate

DESCRIPTION

- 24" Long Flame Bottom Plate, 6" Tall Flames
- Bolt Through, Mounting Hardware Included

Item #	Size	Material	Mounting	Pack
10406B	24"	Chrome	Bolt Through	Bulk = 1 Pc.

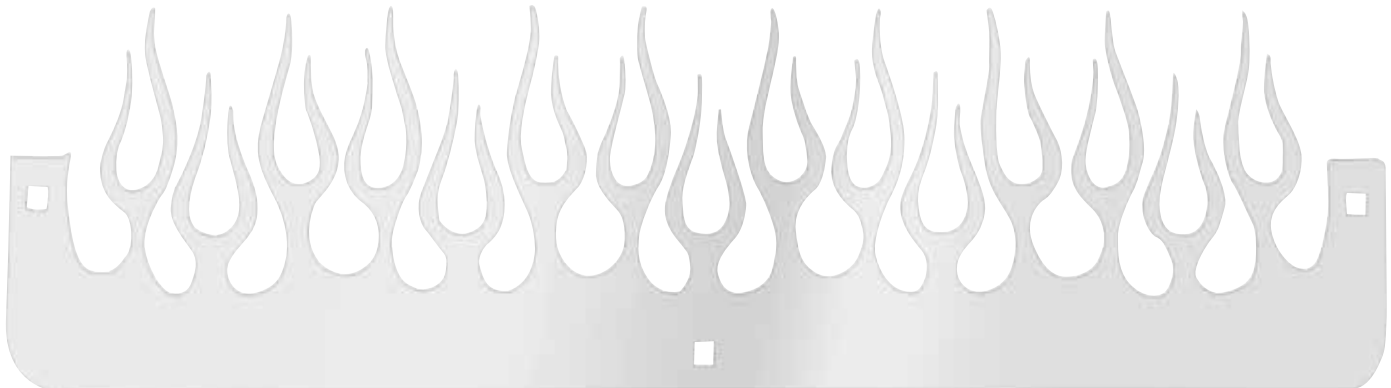

BOTTOM MUD FLAP PLATE/WEIGHT



Bottom Mud Flap Plate - Scripted

DESCRIPTION

- Scripted Bottom Plate for Mud Flaps
- Available in Chrome or Stainless Steel, Mounting Hardware Included, Sold: Bulk = 1 Pc.

Chrome Item #	Stainless Item #	Size	Mounting	Script	Case Qty.
10433	-	4" x 24"	Welded Stud	Largecar	500/Case
10437	21417	4" x 24"	Bolt Thru	Largecar	20/Case
10434	-	4" x 24"	Welded Stud	Petercar	20/Case
10435	-	4" x 24"	Welded Stud	Kwopper	20/Case
10439	21419	4" x 24"	Bolt Thru	Kwopper	20/Case
10436	-	4" x 24"	Welded Stud	Freightshaker	20/Case
10440	-	4" x 24"	Bolt Thru	Freightshaker	20/Case
10431	-	4" x 24"	Welded Stud	Texas	20/Case



Bottom Mud Flap Plate - Plain

DESCRIPTION

- Bottom Plate for Mud Flaps
- Available in Chrome or Stainless Steel, Mounting Hardware Included
- Item with Item # Ending with "C" Denotes Economy Version, Sold: Bulk = 1 Pc.

Chrome Item #	Stainless Item #	Size	Mounting	Style	Case Qty.
10411	21411	4" x 24"	Welded Stud	Standard	20/Case
10411C	-	4" x 24"	Welded Stud	Standard	20/Case
10430	-	4" x 24"	Welded Stud	Contour	20/Case
10416	21409	4" x 24"	Bolt Thru	Standard	20/Case
10416C	-	4" x 24"	Bolt Thru	Standard	20/Case
10417	-	4" x 20"	Bolt Thru	Standard	20/Case
10412	21412	3" x 18"	Welded Stud	Standard	20/Case
10413	21413	3" x 16"	Welded Stud	Standard	20/Case
10414	21414	3" x 14"	Welded Stud	Standard	20/Case
-	21415	3" x 13"	Welded Stud	Standard	14/Case
10415	21416	3" x 12"	Welded Stud	Standard	20/Case

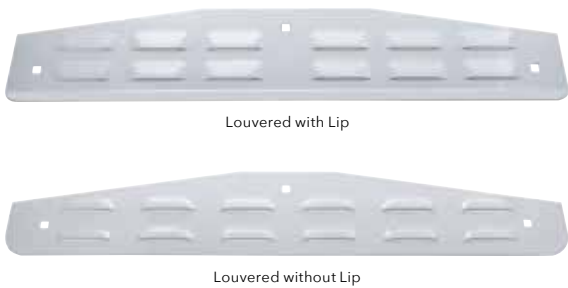

Bottom Mud Flap Plate - Louvered

DESCRIPTION

- Louvered Bottom Plate for Mud Flaps
- Available in Chrome or Stainless Steel, Mounting Hardware Included, Sold: Bulk = 1 Pc.

Chrome Item #	Stainless Item #	Size	Mounting	Lip	Case Qty.
10410	-	4" x 24"	Welded Stud	No	20/Case
10429	20211	4" x 24"	Bolt Thru	No	20/Case
10428	20210	4" x 24"	Bolt Thru	Yes	20/Case
10427	-	3" x 18"	Bolt Thru	Yes	20/Case



10411HW - Welded Stud Kit



10405 - Bolt Thru Kit

Bottom Plate Replacement Hardware Kit

DESCRIPTION

- 10411HW Includes: 3 Nuts and 3 Washer
- 10405 Includes: 3 Bolts, 3 Nuts, 3 Washer, and 3 Rubber Inserts

Item #	Description	Pack
10411HW	Hardware for Welded Stud Bottom Plate	Bulk = 1 Kit
10405	Hardware for Bolt Thru Bottom Plate	Bulk = 1 Kit

United Pacific Rubber Mud Flap

DESCRIPTION

- Black Rubber Mud Flap with United Pacific Logo
- Available in 24", 30", and 36" Long

Item #	Description	Package	Pack
10587	24" x 24" UP Logo Mud Flap	Bulk	1 Pc.
10588	24" x 30" UP Logo Mud Flap	Bulk	1 Pc.
10589	24" x 36" UP Logo Mud Flap	Bulk	1 Pc.



Rubber Mud Flap

DESCRIPTION

- Black 24" Rubber Mud Flap
- Available in 3 Different Lengths, Sold: Bulk = 1 Pair

Item #	Description	Package	Pack
10606	24" x 24" Rubber Mud Flap	Bulk	1 Pair
10607	24" x 30" Rubber Mud Flap	Bulk	1 Pair
10608	24" x 36" Rubber Mud Flap	Bulk	1 Pair



Front Rubber Mud Flap

DESCRIPTION

- Black Front Rubber Mud Flap
- For Front Fender, Battery Box, and Fuel Tank Protector

Item #	Description	Package	Pack
10605	24" x 18" Rubber Mud Flap	Bulk	1 Pair
10604	20" x 15" Rubber Mud Flap	Bulk	1 Pair



Quarter Fender Top Mud Flap

DESCRIPTION

- 6" x 24" Rubber Top Mud Flap For United Pacific Quarter Fender
- 6" x 18" Top Mud Flap (Item # 10609) for Item # 10702

Item #	Description	Package	Pack
10610	6" x 24" Top Mud Flap	Bulk	1 Pc.
10611	6" x 24" Top Mud Flap	Bulk	1 Pc.
10609	6" x 18" Top Mud Flap	Bulk	1 Pc./Bulk

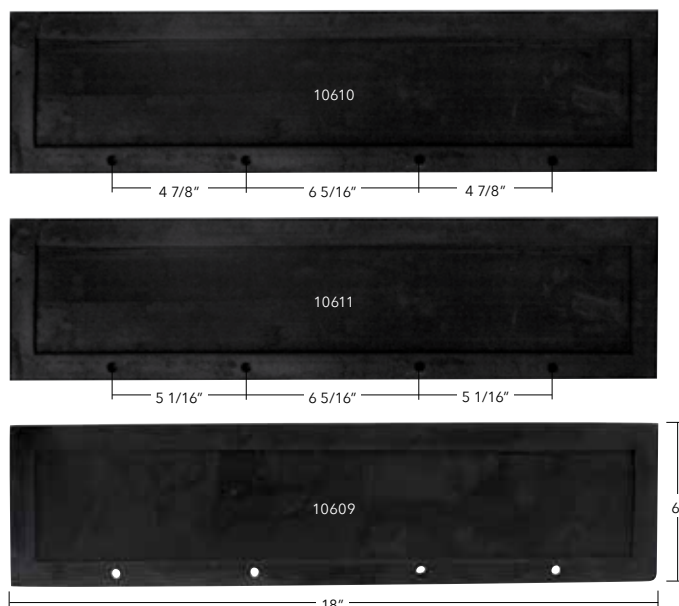

CUTOUTS

Chrome Lady Cutout

DESCRIPTION

- Chrome Sitting Lady Cutout with Welded Studs
- Available in 4 Different Sizes

Item #	Size	Facing	Stud	Pack
10897	3" x 4 1/2"	Right	Welded	Bulk = 1 Pc.
10898	3" x 4 1/2"	Left	Welded	Bulk = 1 Pc.
10899	4" x 6"	Right	Welded	Bulk = 1 Pc.
10900	4" x 6"	Left	Welded	Bulk = 1 Pc.
10901	6 1/2" x 9"	Right	Welded	Bulk = 1 Pc.
10902	6 1/2" x 9"	Left	Welded	Bulk = 1 Pc.
10903	11" x 17"	Right	Welded	Bulk = 1 Pc.
10904	11" x 17"	Left	Welded	Bulk = 1 Pc.

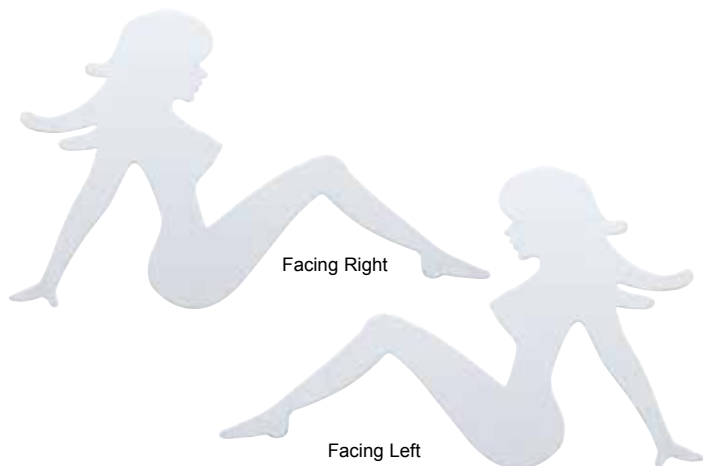

Chrome Long Horn Skull Cutout

DESCRIPTION

- Chrome Long Horn Skull Cutout, Available in 3 Different Sizes
- Available with Welded Studs or Double-sided Tape

Long Horn Skull Cutout - Welded Stud

Item #	Size	Description	Stud	Pack
10912	3 1/4" x 6 1/2"	Small Skull	Welded	Bulk = 1 Pc.
10911	6" x 12"	Medium Skull	Welded	Bulk = 1 Pc.
10910	10 1/2" x 22 1/2"	Large Skull	Welded	Bulk = 1 Pc.

Long Horn Skull Cutout - Double-sided Tape

Item #	Size	Description	Mount	Pack
10897	3 1/4" x 6 1/2"	Small Skull	Double Sided Tape	Bulk = 1 Pc.



Maltese Cross Cutout

DESCRIPTION

- Chrome or Stainless Steel Maltese Cross Cutout
- Available in 2 Different Size

Chrome Maltese Cross Cutout

Item #	Material	Size	Stud	Pack
10952	Chrome	7" x 7"	Welded	Bulk = 1 Pc.

Stainless Steel Maltese Cross Cutout

Item #	Material	Size	Stud	Pack
10954	Stainless	12" x 12"	Welded	Bulk = 1 Pc.
10951	Stainless	12" x 12"	Bolt Thru	Bulk = 1 Pc.
10955	Stainless	7" x 7"	Welded	Bulk = 1 Pc.
10953	Stainless	7" x 7"	Bolt Thru	Bulk = 1 Pc.



Chrome "Pete 359"/"Pete 379" Cutout

DESCRIPTION

- Chrome "Pete 359" or "Pete 379" Cutout with Welded Studs

Item #	Size	Description	Stud	Pack
10937	16 1/4" x 6 3/4"	Pete 359	Welded	Bulk = 1 Pc.
10939	16 1/4" x 6 3/4"	Pete 379	Welded	Bulk = 1 Pc.



Chrome Armadillo Cutout

DESCRIPTION

- Chrome Armadillo Cutout
- Available with Welded Studs or Double-sided Tape

Chrome Armadillo - Welded Studs

Item #	Size	Facing	Stud	Pack
10916	2 1/2" x 8"	Right	Welded	Bulk = 1 Pc.
10915	2 1/2" x 8"	Left	Welded	Bulk = 1 Pc.

Chrome Armadillo - Double-sided Tape

Item #	Size	Facing	Mount	Pack
10923	2 1/2" x 8"	Right	Double Sided Tape	Bulk = 1 Pc.
10922	2 1/2" x 8"	Left	Double Sided Tape	Bulk = 1 Pc.

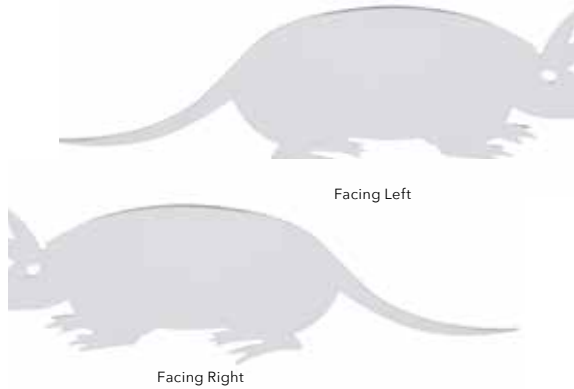
**Chrome Eagle Cutout**

DESCRIPTION

- Chrome Eagle Cutout with Welded Studs
- Available in 2 Different Size

Item #	Size	Facing	Stud	Pack
10919	7 1/2" x 9 1/2"	Right	Welded	Bulk = 1 Pc.
10920	7 1/2" x 9 1/2"	Left	Welded	Bulk = 1 Pc.
10917	12" x 14"	Facing Right	Welded	Bulk = 1 Pc.
10918	12" x 14"	Facing Left	Welded	Bulk = 1 Pc.

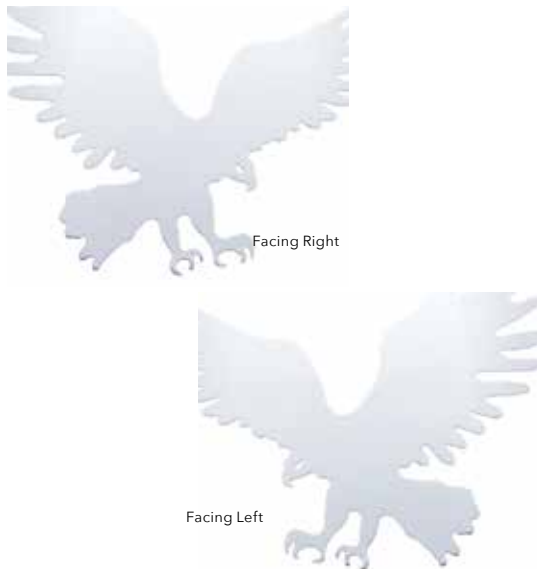
**Stainless Steel Raging Bull Cutout**

DESCRIPTION

- Raging Bull Cutout with Welded Studs

Item #	Size	Facing	Stud	Pack
10908	12" x 7"	Left	Welded	Bulk = 1 Pc.

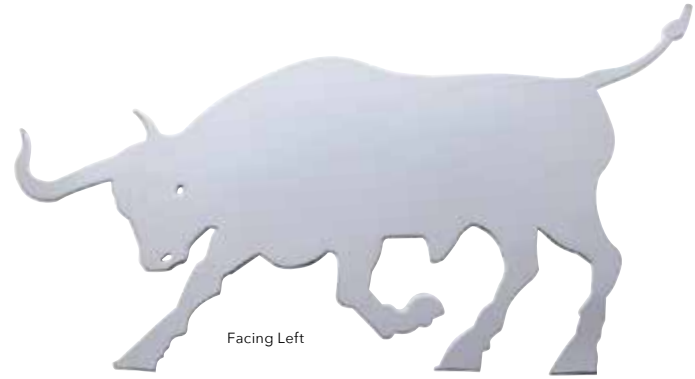
**MY RIG, MY RULES, MY WAY.**

You deserve the BEST! And that's what you get with **UNITED PACIFIC's** Lighting, Interior and Exterior Accessories, and Collision Parts.



THE LEADER IN COMMERCIAL TRUCK PARTS AND ACCESSORIES

truck.uapac.com



IMPORTANT: PLEASE REVIEW CAREFULLY**New Accounts**

Initial minimum buy-in is \$5,000 (or to be determined by United Pacific Industries, UPI hereafter). All initial orders must be prepaid in advance by Cashier's Check or VISA/MC. All new/potential accounts must complete a UPI "New Customer Info/Credit Form" and follow the Dealer Qualification Instructions. Upon completion of the credit application, approved accounts will be assigned payment terms of NET 30 Days (from invoice date). Accounts denied a credit line will be required to prepay in advance by Cashier's Check or VISA/MC.

Payment Terms:**Term Accounts**

Accounts with NET 30 Days terms are required to submit payment within the 30 days from the date of invoice. Acceptable forms of payment include checks, ACH (Automated Clearing House), or wire transfer.

A service charge of 1.5% per month will be imposed on invoices not paid within the 30 day term. Delinquent accounts will be required to pay Cash-In-Advance (CIA). Checks will be accepted but orders will not be released until the check is cleared by the bank. Past due invoices will delay current orders. Please check with UPI on your account status when placing an order.

Credit Cards

Accounts denied credit terms may pay by Visa or MasterCard. Credit card will be charged upon shipment. Credit card payments will not be accepted once an order has been shipped. UPI does not accept American Express or Discover card. A service fee of 3% will be charged on credit card orders.

COD

A \$12.50 fee will be assessed per COD box for all FedEx/UPS COD shipments. Truck COD shipment fees are to be determined later by trucking company.

Returned Checks:

A \$30 NSF (Non Sufficient Fund) fee will be assessed on each incidence a check is returned to UPI.

ORDERING GUIDELINES

Placing Orders: New orders may be placed by any of the following methods

1. Fax: (888) 986-5988
2. E-mail: sales@uapac.com
3. Telephone: In order to minimize errors, customers are encouraged to submit their orders by fax or email. Telephone orders should be limited to smaller orders such as add-ons to orders already submitted and/or fill-ins occurring between larger restocking orders.

Changes to Orders:

Whenever possible, revisions to orders - additions or deletions of items - should also be submitted via fax or email to reduce the possibility of errors.

Additions/Deletion of items will only be accepted within 48 hours after the initial order date and/or before 12:00PM on the date of the shipment. Additions of items placed after the 48 hours time period will be considered a new order and adhere to a new order freight prepaid policy. Deletions of item cannot happen after the 48 hours time period and/or after 12:00PM on the date of the shipment. Please note additions and/or deletions of items will delay the shipment date.

Canceling Orders:

Cancellation of orders must be submitted via fax or email within 24 hours of the order date. If the order has already shipped it will be the customers responsibility to return the order at the customers own expense. A restocking fee may apply, please see "Return" policy for further detail.

Back-orders:

Customers have the option of having their back-orders shipped or canceled. Back-orders resulting from a freight prepaid qualifying order will be shipped freight prepaid. UPI reserves the right to cancel back-orders that are 6 months or older from the initial invoice date.

Minimum Order:

A minimum order of \$50.00 is required. Orders below \$50.00 will be assessed a minimum order fee of \$5.00.

Packaging:

A 10% service charge will be added to orders with special packaging or UPC bar-coding requirements.

Lead Times:

Standard lead time for all United Pacific orders is 1-3 business days from the receipt of the purchase order. Larger orders may require a lead time of up to 5 business days. Transit time of 3-5 business days must be considered when placing orders. UPI cannot be responsible for delays in shipment after an order leaves our warehouse. UPI will work to resolve delays with freight

Forwarding firms, however, delays do arise from time to time due to weather and unforeseen circumstances beyond UPI's control. Express order are exempted; please view Freight/Shipping Policy for further detail.

Order Confirmation:

United Pacific will acknowledge receipt of orders by email/fax/telephone within 1 business day of receipt. If confirmation is not received, please contact UPI to ensure your order was received.

FREIGHT**Prepaid Freight:**

Stock orders between \$50 and \$999.99 (US Lower 48 States), **\$50 and \$2499.99 (Alaska and Hawaii)**, **\$50 and \$1499.99 (Canada)**, [all price net US\$], will be shipped FOB Long Beach, California. Stock orders of \$1,000 (US Lower 48 States), **\$2500 (Alaska and Hawaii)**, **\$1500 (Canada)**, [based on UPI current pricing], or more will be shipped Freight Prepaid Ground to a single location only. (See exception for Oversize Items*). *Express Air orders, Special Net Pricing orders, and Special Quote Pricing orders are excluded.* United Pacific reserves the right to select the carrier of our choice. Customers may select the carrier of their choice at their own expense, negotiated rates and insurance. Special handling charges such as lift gate fee, residential delivery fees are not included in the prepaid freight policy. If customers elect to choose their own freight carrier, orders will be shipped via FREIGHT COLLECT.

Will Call Orders:

Will Call orders can be picked up 2 - 4 hours after placing the order. Customers should always call ahead to confirm when order will be ready to pick up.

IMPORTANT: PLEASE REVIEW CAREFULLY**SHIPPING POLICY****International Shipments:**

Shipments to locations outside the continental United States will be shipped to the customer's shipping agent or broker within the continental United States in accordance with the US freight policy. International customers will be responsible for the duties and taxes of their respective country.

Express Orders:

All express orders, such as Next Day, Second Day, 3 Day Service & Will Call, must be faxed/emailed. Order confirmation will be faxed to the customer for final approval. If confirmation is not received, please contact UPI to ensure your order was received. Customers are required to sign off on express orders and fax confirmation back to UPI. Cut off for express order is 12:00PM. Express orders received after 12:00PM may or may not ship the same day. Please call UPI to confirm projected shipping date or will call time.

Due to the high cost of express shipments, customer may request UPI to call to confirm freight charges. If customer does not request confirmation, UPI will ship the express order.

Drop Shipments:

All drop shipment orders will be assessed a \$10.00 processing fee. Drop shipment processing fee will be automatically added to the invoice without notice. All drop shipment orders must be faxed in. No freight allowance or prepaid freight will be permitted for any drop shipments, thus, all drop ship orders, regardless of order size, are FOB Long Beach, CA.

CLAIMS**General Policy:**

All claims (Shortage, Mis-Shipped, Damage, Overage, Customer Error & Billing Error) must be submitted to UPI within 3 business days of the receipt of shipment. Claims submitted beyond 3 business days of the receipt of shipment will be voided by UPI.

On all shipments, the person who signs and receives the shipment is responsible for noting on the Bill of Lading, in writing, whether any boxes arrived damaged or shorted. Failure to do so will void all claim rights between all parties. UPI will have no recourse against the trucking company if customer does not note any damages or shortages on the Bill of Lading.

The customers receiving department must count and sign for the exact number of boxes received. Failure to follow the above instructions will void all claim rights between all parties.

Shortages / Mis-Ships / Damages

While UPI strives to fill every order with 100% accuracy, on occasion an item may get shipped in error or get damaged during shipping. In the event this occurs, please follow the process below. Note: This type of claim must be reported to UPI within three (3) business days of receiving the order.

1. Contact the United Pacific office to initiate the claim. To make it easy for you we have two acceptable methods for requesting the claim:

* By e-mail : returns@uapac.com

* By fax : (888) 986-5988

* **Note: To ensure you receive a timely credit, we cannot accept claim requests by phone.**

2. You will be required to provide the following information:

* Your business name

* Contact name and telephone number (in case we have questions)

* Date the order was received

* A copy of the Packing List / Invoice noting the Item # and quantity that was shipped in error or damaged during shipping.

* Special instructions you have for us.

3. UPI will send a return label so you can ship the items back.

4. Once we receive the miss-shipped/damaged item(s) a credit will be issued to your account on the next billing cycle.

5. Shortages will be credit to the Customers' account, unless customer would like the shortages replaced.

Overages:

UPI strives to provide our customers with the best customer service and products, in turn we would greatly appreciate any help from customer in notifying UPI of any shipping overages. Customers will be offered the option of retaining the merchandise or returning the merchandise to UPI at UPI's expense. If the items are to be returned, an RMA number and return shipping label will be provided.

Customer Errors:

Any item or quantity ordered in error by the customer may be returned by contacting UPI for a RMA No.

1. To make it easy for you we have two acceptable methods for requesting the RMA:

* By e-mail: returns@uapac.com

* By fax: (888) 986-5988

* **Note: To ensure you receive a timely RMA credit, we cannot accept RMA requests by phone.**

2. You will be required to provide the following information.

* Your business name

* Contact name and telephone number (in case we have questions)

* A list of the items number and quantity ordered in error

* Special instructions you have for us

3. UPI will review the request to ensure the products are within the return period.

4. Once we have validated the request, United Pacific will issue an RMA number to the customer. In issuing the RMA approval, the following conditions will apply :

* Returned items are subject to a 20% re-stocking fee.

* Return shipping costs are the responsibility of the customer.

* Items must not have any retail/price sticker on exterior packaging or they will be returned to the customer at customer's expense and no credit given.

* Items must be in good condition with original packaging intact or they will be returned to the customer at customer's expense and no credit given.

* Allow up to 30 days for the credit to be issued from the time the returned items are received.

Billing Errors:

Billing errors should be reported to UPI within 3 business days of invoice receipt. Customers are asked to provide the invoice number, part number, and quantities in question. Once verified, UPI will issue a credit or an invoice for the difference in billing error.

IMPORTANT: PLEASE REVIEW CAREFULLY**WARRANTY POLICY****General Policy:**

UPI offers a NO HASSLE WARRANTY RETURN policy to all our customers. Warranty claims can only be submitted through an authorized UPI Distributor. UPI warranty is not transferable and applies to the original installation and purchase only. In no event shall UPI be liable for incidental or consequential damages, nor shall UPI be liable for any claims or damages arising out of or connected with the UPI warranty exceed the purchase price of the products. There are no warranties, expressed or implied (including any warranty of merchantability or fitness) that extend beyond this warranty. The warranty does not apply to costs associated with the loss of use of the product, loss of time, inconvenience, commercial loss, incidental or consequential damages. UPI reserves the right to alter the designs of products without assuming any obligation to modify previously manufactured products and will only replace warranted products with redesigned products.

Warranty does not apply to merchandise that has been drilled, cut, welded, modified in any way or installed contrary to normal installation and usage. In addition, UPI cannot be held liable for damages caused by road hazards, accidents, misuse, neglect, abuse or corrosive environments including acid washes and highway snow/ice chemicals which can cause discoloration and corrosion in aluminum, chrome, stainless steel and light products. UPI reserves the right to credit returned merchandise at the initial purchase price or at the current selling price, which price ever is lower.

Aluminum / Chrome / Stainless Steel Products:

All aluminum, chrome, and stainless steel products carry a limited 6 month warranty (from invoice date) against defects in material or workmanship.

Lighting Products:**Incandescent**

All incandescent lighting products carry a limited 12 month warranty (from invoice date) against defects in material or workmanship. The limited 12 month warranty does not apply to several applications, such as, buses, construction equipment, and off road vehicles.

LED

All LED lighting products carry a specific Limited* Warranty (from invoice date) against defects in material or workmanship.

- * LED Marker, 2", 2-1/2", 4", 7", Oval & Square Lights - Varies from 2 years to 10 years to Limited Lifetime, depending on specific item. The housing, bezel or mounting base on any light made from Chrome/Stainless carries a 6 month limited warranty.
- * LED Cab Lights and Kits, Double/Single Stud Turn Signal and PB/KW/FL/VL or non-make Turn Signals and any/all Strip Lights - Varies from 2 years to 10 years to Limited Lifetime, depending on specific item. The housing, bezel or mounting base on any light made from Chrome/Stainless carries a 6 month limited warranty.
- * LED Beacon, Driving, Headlights, Work & Warning Lights - Varies from 6 months to 3 years. The housing, bezel or mounting base on any light made from Chrome/Stainless carries a 6 month limited warranty.
- * All LED Accessory Lights (Honda, Stainless Steel Double/Single face Lights, Interior Lights, License Plate Lights, and any Accent Lights. The housing, bezel or mounting base on any light made from Chrome/Stainless carries a 6 month limited warranty.

RETURNS**General Policy:**

All returns must be authorized by UPI. All return requests must be faxed or e-mailed (returns@uapac.com) A RMA number (Return Merchandise Authorization Number) will be provided. Returns not possessing a valid RMA number are subject to rejection and will be returned to sender at the

customer's expense.

All customers are encouraged to use the Warranty RMA Claim Form.

Defective Goods / Warranty Return:

UPI offers our customers a No Hassle Warranty Return. Please follow the instructions below for requesting a RMA for defective goods:

1. If any warranty issues occur, simply contact the UPI for RMA number
To make it easy for you we have two acceptable methods for requesting the RMA:
 - * By e-mail: returns@uapac.com
 - * By fax: (888) 986-5988
 - * **Note: To ensure you receive a timely RMA credit, we cannot accept RMA requests by phone.**
2. You will be required to provide the following information:
 - * Your business name
 - * Contact name and telephone number (in case we have questions)
 - * A list of the defective Item # and quantity with the nature/reason of the defect
 - * Special instructions you have for us
 - * The enclosed fax form may be used for your convenience to request an RMA
3. UPI will review the request to ensure the products are within the stated warranty period.
4. Once we have validated the warranty items, a RMA confirmation, listing the items and cost will be faxed to the customer within 3 business days. UPI will process the credit to your account within 30 days.

Note: There will be no need to return the warranty product to us. However, from time to time, UPI may require some warranty products to be shipped back so we may analyze the cause of the failure. All warranty products that are required to be shipped back will be freight prepaid by UPI.

Stock Return

United Pacific Industries encourages all customers to regularly monitor the sales volume and stock level of their inventory items. As sales trends may slow the movement of specific items, our hope is that those items are featured as "close-out specials" as to minimize stock returns. We also understand that the customer, from time to time, may accumulate over-stock items and desire to return those. Therefore, we have adopted the following policy below.

NOTE:

- * Items must have been purchased by the dealer requesting the stock return.
- * Items must have been purchased within the preceding 12 months.
- * Items that have been discontinued will not be considered for return.

1. Contact the United Pacific office for RMA number We have 2 acceptable methods for requesting the RMA:
 - By e-mail : returns@uapac.com
 - By fax : (888) 986-5988
 - * **Note: To ensure you receive a timely RMA credit, we cannot accept RMA requests by phone.**
2. You will be required to provide the following information:
 - * Your business name
 - * Contact name and telephone number (in case we have questions)
 - * A list of defective items: Item #s and quantity of each
 - * Special instructions you have for us
3. Your claim will be reviewed within 5 business days and you will be contacted by your sales representative who will discuss solutions to liquidate these slow moving items.

IMPORTANT: PLEASE REVIEW CAREFULLY

4. In the event United Pacific and the customer agree to a credit in lieu of returning the items, this credit will be issued within 10 business days.
5. In the event items are returned by the customer, United Pacific will issue an RMA number to the customer. In issuing the RMA approval, the following conditions will apply:
 - * Returned items are subject to a 20% re-stocking fee.
 - * Return shipping costs are the responsibility of the customer.
 - * Items must not have any retail/price sticker on exterior packaging or they will be returned to the customer at customer's expense and no credit given.
 - * Items must be in good condition with original packaging intact or they will be returned to the customer at customer's expense and no credit given.
 - * Allow up to 30 days for the credit to be issued from the time the returned items are received
6. Stock returns may be requested throughout the year and are subject to a maximum of 5% of prior year annual purchases.

Closeout/Discontinue Items:

UPI will not warranty or accept returns on Closeout/Discontinue items.

Procedure:

An inventory of the merchandise being returned must accompany each return. The RMA number should be prominently displayed on each carton/box.

All Returns must be returned freight prepaid.

Ship Returns to:

United Pacific Industries
Attn: Returns Department
3788 E. Conant St.
Long Beach, CA 90808

RMA's:

Outstanding RMA's will be automatically canceled if not used within 30 days of issuance.

CATALOGS**General Policy:**

UPI will send a set of catalogs and price lists upon the arrival any new catalogs and price list. Included in the mailing will be a Catalog Order Form in which customers can request additional copies.

Catalog/CD Request:

UPI provides additional catalogs/CD's to our customers free of charge. Customer must submit their request on a UPI Catalog Order Form or add the request to their regular restocking order. Requests for additional catalogs/CD's should be submitted along with the regular restocking orders to avoid additional freight charges. Due to the availability of catalogs/CD's, customer's request may be limited to certain quantity. Catalogs/CD's will be shipped along with the customers' order. Customer may request the catalogs be shipped separately, but customer will be responsible for the freight charge.

Picture Request

All UPI item pictures are taken professionally by our marketing department. Item pictures can be downloaded online at www.uapac.com. Item pictures not posted online can be requested by sending an email to e-mail graphic@uapac.com. All picture requests must state the item no and the format of the picture file, i.e. jpeg or high resolution. UPI has over 20,000 SKU's and therefore does not have a CD with all the items.

DISCLAIMER

United Pacific Industries reserves the right to amend or update our Policies & Procedures without notice.

RMA FORM SAMPLE

DEFECTIVE GOODS / WARRANTY CLAIM FORM

UNITED PACIFIC INDUSTRIES, INC.
3788 E. CONANT ST.
LONG BEACH, CA 90808
CONTACT: (562) 421-3888
TOLL FREE: (800) 790-6988
TOLL FREE FAX: (800) 588-5888

Date: _____
Company Name: _____
Address: _____
City, State, Zip: _____
Contact Name: _____
Phone Number: _____
Fax Number: _____
E-mail: _____

Item #	Quantity	Description	Reason for Defect	Date sent to Customer

Any special notes / instructions for United Pacific (list here): _____

File your claim at: www.uapac.com
By Fax: (562) 421-3888

When we cannot accept any other request

Internal Use Only

Date Received: _____ Final RMA: _____
RMA Approval Date: _____ Credit Amount: _____
RMA Number: _____ Approved By: _____

CATALOG ORDER FORM SAMPLE

UNITED PACIFIC CATALOG ORDER FORM

UNITED PACIFIC INDUSTRIES, INC.
3788 E. CONANT STREET
LONG BEACH, CA 90808
TEL: (562) 421-3888
FAX: (562) 421-3888
TOLL FREE: (800) 790-6988

Date: _____
Company Name: _____
Address 1: _____
Address 2: _____
City, State, Zip: _____
Contact Name: _____

Item #	Description	Quantity	Total
1	UCAC1 UP AIR CLEANER CATALOG, 1 ST EDITION		
2	UCEH1 UP EXHAUST CATALOG 1 ST EDITION		
3	UCFL2 UP INTERIOR PRODUCT CATALOG - FREIGHTLINER, 2 ND EDITION		
4	UCFM3 UP FENDER, REAR LT BARR/PANEL, MUD FLAP ACCESSORIES, 3 RD EDITION		
5	UCIH1 UP INTERNATIONAL PRODUCT CATALOG, 1 ST EDITION		
6	UCKS2 UP KEYSTONE POLISHING CATALOG, 2 ND EDITION		
7	UCKW2 UP INTERIOR PRODUCT CATALOG - KENWORTH, 2 ND EDITION		
8	UCLT2 UP MASTER LIGHTING CATALOG, 2 ND EDITION		
9	UCMFL1 UP MINI FREIGHTLINER INTERIOR PRODUCT CATALOG		
10	UCMKW1 UP MINI KENWORTH INTERIOR PRODUCT CATALOG		
11	UCMKWS1 UP MINI SPANISH KENWORTH INTERIOR PRODUCT CATALOG		
12	UCMPB1 UP MINI 2008+ PETERBILT INTERIOR PRODUCT CATALOG		
13	UCNW2 UP NUT COVER & WHEEL PRODUCT CATALOG, 2 ND EDITION		
14	UCPB3 UP INTERIOR PRODUCT CATALOG - PETERBILT, 3 RD EDITION		
15	UCSC3 UP SPECIALTY COLLISION CATALOG 3 RD EDITION		
16	UCHT2 UP TRAIN HORN & AIR COMPRESSOR CATALOG, 2 ND EDITION		
17	UCWL1 UP WORK, DRIVING, AND WARNING LIGHT CATALOG, 1 ST EDITION		
18	UP1210 2011 UP ANNUAL NEW ITEM SUPPLEMENT (NEW ITEM FROM 2010)		
19	UP1112 2011-2012 NEW ITEM FLYER COLLECTION		
20	UP1214 2014 ANNUAL NEW ITEM SUPPLEMENT (NEW ITEM FROM 2013 & 2014)		
21	UP1215 2015 ANNUAL NEW ITEM SUPPLEMENT (NEW ITEM FROM 2015)		
22	UCLED2 UP LED LIGHTING PRODUCT CATALOG, 2 ND EDITION		
23	99046 UNITED PACIFIC DELUXE BINDER 3 1/2" THICK		

Any special notes / instructions for United Pacific (list here): _____

Please read the following policies for ordering catalogs:
A) All orders for brochures, catalogs, and price books will be shipped with the customers' next regular order.
B) If you want your brochures to ship independent of your next order, extra shipping fees will be applied and billed to your account. Please approve the shipping fees by providing a signature below.

Signature X _____

Item #	Page #	Item #	Page #	Item #	Page #	Item #	Page #	Item #	Page #
10389	48	10446	42	10637	8	10784	9	10846	37
10390	48	10447	41	10638	38	10785	9	10847	37
10391	48	10451	41	10639	36	10786	7	10849	34
10392	48	10451C	41	10640	43	10787	4, 7	10850	34
10393	48	10452	41	10641	43	10788	9	10852	9
10394	48	10453	41	10643	37	10789	9	10853	9
10395	48	10454	41	10644	43	10790	4, 7	10854	4
10396	48	10456	42	10645	37	10791	4, 7	10855	4
10397	48	10456L	42	10646	37	10792	4, 7	10856	6
10398	48	10456R	42	10647	35	10793	4, 7	10857	6
10399	48	10457	42	10648	35	10794	4, 7	10858	6
10400	50	10520	42	10649	37	10795	4, 7	10859	6
10401	50	10585	5	10650	37	10796	7	10860	37
10401C	50	10587	52	10651	37	10798	4, 7	10861	37
10401HW	50	10588	52	10652	37	10800	7	10897	53
10402	50	10589	52	10653	34	10804	10	10898	53
10402C	50	10601	39	10654	34	10806	4, 7	10899	53
10403	50	10604	52	10655	34	10807	8	10900	53
10404	50	10605	52	10656	35	10808	4	10901	53
10405	51	10606	52	10657	44	10809	4	10902	53
10406B	50	10607	52	10658	44	10810	4	10903	53
10410	51	10608	52	10659	44	10814	4	10904	53
10411	51	10609	52	10660	34	10815	6	10908	54
10411C	51	10610	52	10661-1	41	10816	6	10910	53
10411HW	51	10611	10, 52	10665	40	10817	6	10911	53
10412	51	10613	38	10665-1	41	10818	6	10912	53
10413	51	10614	38	10667	40	10819	6	10915	54
10414	51	10615	38	10668	34	10820	6	10916	54
10415	51	10619	4	10669	34	10821	6	10917	54
10416	51	10620	4	10670	34	10822	6	10918	54
10416C	51	10621	4	10671	38	10823	9	10919	54
10417	51	10622	5	10672	38	10824	9	10920	54
10427	51	10624	4	10674	37	10825	6	10922	54
10428	51	10625	38	10675	40	10826	6	10923	54
10429	51	10626	38	10677	40	10827	6	10937	53
10430	51	10627	38	10681	37	10828	6	10939	53
10431	51	10628	4, 5, 7	10684	37	10831	4, 9	10951	53
10433	51	10629	4, 8	10685	37	10832	9	10952	53
10434	51	10630	8	10686	35	10833	34	10953	53
10435	51	10631	8	10687	35	10834	34	10954	53
10436	51	10632	5, 8	10697	34	10836	34	10955	53
10437	51	10633	4, 8	10702	5	10838	34	10980	40
10439	51	10634	4, 10	10711	4, 5	10839	10	10981	40
10440	51	10634-1	4, 10	10712	35	10841	34	10982	40
10441	40	10635	10	10782	9	10842	34	10983	40
10441P	40	10636	4	10783	9	10843	34	10984	40

Item #	Page #	Item #	Page #	Item #	Page #	Item #	Page #	Item #	Page #
10985	40	20572	2	21426	47	22451	41	31616	16, 17, 22
10986	40	20583	3	21428	47	22452	41	31617	22
10987	40	20584	2	21430	42	22453	41	31619	22
10988	40	20585	2	21431	42	25001	9	31620	16
10990	40	20611	40	21432	50	29041	3	32550	1
10991	40	20611P	40	21437	31	29042	3	32551	1
10992	40	20865	48	21460	23	29043	3	32560	1
10993	40	20866	48	21462	23	29044	3	32561	1
10994	40	20867	48	21474	26	29056	3	32562	1
10995	40	20868	48	21475	27	29070	3	32563	1
10996	40	20996	12	21478	25	30168	28	32564	1
10997	40	21348	46	21493	24	30208	31	32565	1
10998	40	21349	46	21495	29	30209	31	32566	1
11200	6	21353	46	21496	29	30221	32	32567	1
11201	6	21354	46	21499	29	30222	32	32568	1
11202	6	21360	46	21501	28	30223	32	32569	1
11203	6	21361	46	21502	28, 30	30224	12	32570	1
11204	6	21364	46	21512	28, 30	30226	15	32571	1
11205	6	21365	46	21608	29	30227	14, 15	32572	1
11206	6	21366	46	21609	29	30231	13, 15	32573	1
11207	6	21367	46	21611	29	30231-1	12	33636	23
11208	6	21370B	47	21612	29	30237	11, 12	33637	23
11209	6	21372	47	21653	28, 30	30274	12	33638	23
11210	6	21374	47	21654	28, 30	30678	2	33639	23
11211	6	21381	46	21655	28, 30	30890B	39	33681	28
11212	6	21384	46	21656	28, 30	30891B	39	33682	28
11213	6	21385	46	22237	16, 18, 22	30918	45	33683	28
11214	6	21391	45	22238	22	31004	15	33685	28
11215	6	21393	45	22240	22	31005	15	33686	28
11216	6	21396	47	22300	16, 18, 22	31009	22	33687	28
11217	6	21397	45	22301	16, 19, 22	31011	22	33736	23
11218	6	21398	45	22302	16, 20, 22	31065	28, 29, 30	33737	23
11219	6	21400	45	22303	16, 21, 22	31068	29	33738	23
11220	6	21407	50	22304	16, 21, 22			33739	23
11221	6	21408	50	22350	22	31109	12, 15, 22, 28, 29, 30, 31, 43, 45	33781	28
11222	6	21409	51	22351	22			33782	28
11223	6	21411	51	22353	22			33783	28
11300	35	21412	51	22354	22			33785	28
11310	35	21413	51	22355	22	31362	15, 22, 44	33786	28
11320	35	21414	51	22357	22	31364	32	33787	28
20209	50	21415	51	22359	22	31595	30	33836	23
20210	51	21416	51	22360	22	31601	31	33837	23
20211	51	21417	51			31611	15	33838	23
20231	12	21419	51			31615	16, 19, 22	33839	23
20235	12	21422	47					33881	28
20237	11, 12	21424	47						

Item #	Page #	Item #	Page #	Item #	Page #	Item #	Page #	Item #	Page #
33882	28	34614	30	35066	27	35268	26	37221	49
33883	28	34620	31	35067	26	35269	26	37222	49
33885	28	34621	31	35068	26	35270	26	37223	49
33886	28	34622	31	35069	26	35272	26	37224	49
33887	28	34623	31	35070	26	35273	26	37225	49
34047B	47, 48	34662	29	35071	26	35312	28	37226	49
34059B	48	34663	29	35072	26	35313	28	37318	48
34280	24	34664	24	35112	28	35318	30	37319	48
34480	24	34665	24	35113	28	35319	30	37320	48
34500	29	34666	24	35118	30	35322	31	37321	48
34501	29	34667	24	35119	30	35323	31	37896B	1
34502	29	34696	23	35122	31	36862B	49	37898B	1
34504	29	34697	23	35123	31	36864B	49	38095B	44
34505	29	34700	29	35157	25	36924B	21, 44		11, 13, 17, 18, 19, 23, 28, 29, 30, 31, 43
34506	29	34701	29	35158	25	37036B	45	38116B	
34508	30	34702	29	35159	25	37080	48		
34509	30	34704	29	35160	25	37082	48		
34510	30	34705	29	35161	27	37089B	48		
34512	30	34706	29	35162	27	37090B	48		11, 13, 17, 18, 19, 23, 28, 29, 30, 31, 43
34513	30	34708	30	35163	27	37091B	48	38117B	
34514	30	34709	30	35164	27	37092B	48		
34520	31	34710	30	35165	27	37105	49		
34521	31	34712	30	35166	27	37106	49	38121B	14, 21, 44
34522	31	34713	30	35167	26	37107	49		
34523	31	34714	30	35168	26	37108	49	38122B	14, 44
34559	32	34720	31	35169	26	37109	49	38134B	2
34560	32	34721	31	35170	26	37110	49	38169B	45
34562	29	34722	31	35171	26	37111	49	38170B	36
34563	29	34723	31	35172	26	37112	49	38171B	24, 26, 36, 45
34564	24	34762	29	35212	28	37113	49		
34565	24	34763	29	35213	28	37114	49	38177B	25, 28, 29, 30
34566	24	34764	24	35218	30	37128B	21, 44		
34567	24	34765	24	35219	30		17, 18, 19, 20, 24, 26, 27, 43	38179B	28, 29, 30
34596	23	34766	24	35222	31	37132		38218B	2
34597	23	34767	24	35223	31			38231B	46
34600	29	34796	23	35257	25		17, 18, 19, 20, 26, 27, 43	38234B	46
34601	29	34797	23	35258	25	37134		38257B	46
34602	29	35057	25	35259	25			38285B	46
34604	29	35058	25	35260	25	37166	39	38287B	46
34605	29	35059	25	35261	27	37167	39	38297B	46
34606	29	35060	25	35262	27	37168	39	38305B	2
34608	30	35061	27	35263	27	37169	39	38307B	2
34609	30	35062	27	35264	27	37217	49	38319B	44
34610	30	35063	27	35265	27	37218	49	38362B	36
34612	30	35064	27	35266	27	37219	49	38363B	24, 26, 36, 45
34613	30	35065	27	35267	26	37220	49		

Item #	Page #	Item #	Page #	Item #	Page #	Item #	Page #	Item #	Page #
38365B	25, 28, 29, 30		11, 13, 17, 18, 19, 20, 43	61467	13	61715	44	61961	43
38367B	45	39642B		61468	13	61716	45	62411	11
38411B	45			61469	13	61717	45	62412	11
38413B	45		11, 13, 17, 18, 19, 20, 43	61470	13	61718	45	62413	11
38463B	48	39643B		61481	14	61719	45	62414	11
38464B	48			61482	14	61720	45	62419	11
38469B	47, 48	39644B	1	61483	14	61721	45	62420	11
38470B	47, 48	39645B	49	61543	17	61722	45	62421	11
38747B	32	39703B	14, 21, 44	61544	17	61723	45	62422	11
38749B	32			61545	17	61724	18	62467	13
		39705B	14, 21, 44	61546	17	61725	18	62468	13
	11, 13, 17, 18, 19, 20, 23, 24, 25, 26, 27, 28, 29, 30, 31, 43	39773B	1	61551	18	61726	18	62469	13
38770B		39774B	49	61552	18	61727	18	62470	13
		39775B	1	61553	18	61728	19	62481	14
		39776B	49	61554	18	61729	19	62482	14
		39868	2	61643	19	61730	19	62483	14
		39869	2	61644	19	61731	19	62647	11
	11, 13, 17, 18, 19, 20, 23, 24, 25, 26, 27, 28, 29, 30, 31, 43	39870	2	61645	19	61732	20	62648	11
38772B		39871	2	61646	19	61733	20	62649	11
		39872	2	61647	11	61734	20	62650	11
		39873	2	61648	11	61735	20	62659	13
			11, 13, 17, 18, 19, 20, 23, 24, 25, 26, 27, 28, 29, 30, 31, 43	61649	11	61736	11	62660	13
38774B	14, 21, 44			61650	11	61737	11	62663	14
38776B	44	39924B	23, 24, 25, 26, 27, 28, 29, 30, 31, 43	61659	13	61738	11	62664	14
38849B	36			61660	13	61739	11	62776	11
38850B	36, 45			61663	14	61740	13	62777	11
38851B	36			61664	14	61741	13	62778	11
38852B	36, 45		11, 13, 17, 18, 19, 20, 23, 24, 25, 26, 27, 28, 29, 30, 31, 43	61675	17	61746	17	62779	11
38943B	47			61676	17	61747	17	62780	13
38945B	47	39925B	11, 13, 17, 18, 19, 20, 23, 24, 25, 26, 27, 28, 29, 30, 31, 43	61677	18	61748	18	62781	13
38946B	1			61678	18	61749	18	63300	21
38947B	49			61679	19	61750	19	63302	21
38948B	1			61680	19	61751	19	63304	21, 22
38949B	49	61300	21	61702	43	61758	43	63306	21
39251B	47	61302	21	61703	43	61759	43	63543	17
39253B	47	61304	21, 22	61704	43	61760	43	63544	17
39399B	46	61306	21	61705	43	61761	43	63545	17
39401B	46	61411	11	61706	43	61800	18	63546	17
39402B	46	61412	11	61707	43	61801	18	63551	18
39404B	46	61413	11	61708	44	61802	19	63552	18
39451B	2	61414	11	61709	44	61803	19	63553	18
39452B	46	61419	11	61710	44	61804	20	63554	18
39453B	2	61420	11	61711	44	61805	20	63643	19
39454B	46	61421	11	61712	44	61806	21	63644	19
		61422	11	61713	44	61807	21	63645	19
				61714	44	61960	43	63646	19

Item #	Page #	Item #	Page #	Item #	Page #
63675	17	63758	43	63806	21
63676	17	63759	43	63807	21
63677	18	63760	18	63808	49
63678	18	63761	18	63809	49
63679	19	63762	18	63810	49
63680	19	63763	18	63811	49
63702	43	63764	19	63812	49
63703	43	63765	19	63813	49
63704	43	63766	19	63814	49
63705	43	63767	19	63815	49
63706	43	63768	20	65000	36
63707	43	63769	20	65001	36
63708	44	63770	20	65002	36
63709	44	63771	20	65003	36
63710	44	63772	17	65004	36
63711	44	63773	17	65005	36
63712	44	63774	17	65006	36
63713	44	63775	17	65007	36
63714	44	63776	18	66000	36
63715	44	63777	18	66001	36
63716	45	63778	18	66002	36
63717	45	63779	18	66003	36
63718	45	63780	19	66004	36
63719	45	63781	19	66005	36
63720	45	63782	19	66006	36
63721	45	63783	19	66007	36
63722	45	63784	21	67000	36
63723	45	63785	21	67001	36
63724	18	63786	21	67002	36
63725	18	63787	21	67003	36
63726	18	63788	21	67004	36
63727	18	63789	21	67005	36
63728	19	63790	21	67006	36
63729	19	63791	21	67007	36
63730	19	63792	44, 48	70607	42
63731	19	63793	44, 48	70627	42
63732	20	63794	44, 48	89001	38
63733	20	63795	44, 48	90610	41
63734	20	63796	45	90611	41
63735	20	63797	45	99068	35
63746	17	63800	18	FF379-01L	1
63747	17	63801	18	FF379-01R	1
63748	18	63802	19		
63749	18	63803	19		
63750	19	63804	20		
63751	19	63805	20		



truck.uapac.com

3788 E. Conant St., Long Beach, CA 90808

F: 888.986.5988

T: 800.790.6988

E: sales@uapac.com

 Like us on Facebook: www.facebook.com/uapac.truck/

